

1.Introduction.....	1
2.Safety use.....	1-3
3.Structure and Performance.....	4-5
4.Specification.....	6
5.Installation, Folding and Debugging.....	6-8
6.Use and Operation.....	9-12
7.Fault Diagnosis and Troubleshooting.....	12
8.Safety Devices and Accident Treatment.....	13
9.Maintenance.....	13-15
10.Transportation and Storage.....	16
11.Opening and Checking.....	16
12.Quality Assurance.....	16-17
Figures.....	18

非会员水印

Read and follow all instructions, warnings, and notes in this manual before attempting to operate your power wheelchair for the first time. If there is any information in this manual which you do not understand, or if you require additional assistance for assembly or operation, please contact with your authorized local provider. These symbols below in this manual are used to identify warnings and important information. All of them are very important to your safety. It is strongly recommended that you should read and understand them completely.

**WARNING**

Failure to heed the warnings in the manual may result in personal injury.

**ATTENTION**

Failure to heed the cautions in the manual may result in damage to the power wheelchair.

1. INTRODUCTION

1.1 This product integrates advanced technology with modern style. Especially, its structure for quick dis-assembly and assembly are very convenient for you to store or place at the trunk of your vehicle while traveling. We are certain that the design features, excellent performance and trouble-free operation of this product will ensure your daily life more convenient.

1.2 This product is suitable for all the disabled persons, the elderly and the infirm who have difficulty in walking. The maximum user weight is 120kg.

1.3 This product is of an outdoor type. It is of Model W5521. Here, "W" indicates an outdoor power wheelchair, "5" the code of category of products, "521" the serial number of this type.

1.4 This product is suitable for an outdoor use and the flat streets near buildings for a middle distance, but not for the grass, gravel, or slope of more than 9 degrees and motorized roads, and also not for rainy day.

2. SAFETY USE

2.1 EXPIRATION DATE

This power wheelchair is energy, non-asepsis, reusable product without chemical substances.

The safe and period of validity for the wheelchair on the clinical use not only depends on its structural strength of products, but also on the user usage and use of the product environment, user habits, whether in accordance with the periodic maintenance, maintenance and other factors.

Our products are valid from the date of production for 7 years.

2.2 Instructions before use

2.2.1 If not completely read and understand the user manual, please do not drive.

2.2.2 The maximum loading capacity is 120kg, please do not overload driving. And it is single use, please do not carry passengers.

2.2.3 Please do not drive after drunk or too tired.

2.2.4 Do not drive at night or in the case of a unclear line of sight.

2.2.5 Please self-test before driving and refer to the manual section 5.3 "Commissioning" and 6.2.1 "Practice before operation" if drive for the first time.

2.2.6 This power wheelchair is not waterproof, do not expose in rain and snow as well as drive in rain or snow.(Figure 2)

2.2 Notice on use

2.3 Attention during using

2.3.1 This power wheelchair can drive on a good flat surface, do not drive on muddy, rugged, soft, narrow, icy road, bad roads without guardrails or waterway. (Figure 3)

2.3.2 This power wheelchair has the certain ability of groove obstacle, at this time you should decelerate and cross the obstacle slowly.

2.3.3 This power wheelchair has the certain climbing ability, the maximum slope is 6°.

(Figure 4)

2.3.4 Please avoid driving in the crowds, traffic and other places with heavy traffic.

2.3.5 Please ensure that the controller system fix well, joystick is straight and correct. Sit well and promptly fasten protective tape, keep your head as backward as possible and lean against the backrest in case of bumps in the road, which may lose control.

2.3.6 Press the on/off button, firstly check if the current fastest speed setting is appropriate for yourself operating proficiency, or it should be adjusted for safety; We recommend that we should drive slowly at the beginning for every use, and gradually accelerate as well.

**WARNING**

If your wheelchair moves accidentally, please immediately release the joystick so that the wheelchair will stop moving automatically. If the joystick is out of control and the brake fails, please cut off the power.

**ATTENTION**

Please adjust the brake lever into electric mode when the power wheelchair stop at the incline, or it will taxiing at low speed, resulting in personal injury.

2.4(EMI) Electromagnetic Interference

Your wheelchair may be traveling in the areas affected by electromagnetic interference from some radio transmitters such as radio, wireless intercom, mobile phones and radars etc. In these cases, your wheelchair's driving may be affected by them. Electromagnetic interference may affect the control system of the power wheelchair. Some disturbances may cause brake failure, automatic start or runaway, and may cause permanent damage to the control system.

2.4.1 Electromagnetic Interference Classification

- Short-band radio transceiver. These radios have antennas, such as radio waves in the urban bands, walkie-talkies, cell phone network systems and signal transmission devices.
- Medium-band mobile radio transceiver. These are usually installed in the building or outside the vehicle antenna. For example: police, fire, tax, medical ambulance and other radio transceivers.
- Large band radio transceiver. These are usually installed on the tower in the antenna, such as: commercial radio TV transmission system.



ATTENTION

Wheelchair and battery chargers meet GB / T 18029.21 Wheelchair - Part 21: Requirements and test methods for electromagnetic compatibility of power wheelchair, electric scooters and battery chargers.



ATTENTION

The wheelchair during driving may be affected by Electro-Magnetic Interference(EMI). Such interference may be from mobile phones, EAS system, etc.

2.4.2 Prevention of Electromagnetic Interference

- Do not use hand-held radio transceivers when the wheelchair power is turned on, such as mobile phones, radios, etc;
- Avoid close to the radio transmission system, such as radio stations, television stations;
- If the power wheelchair is out of control or brake fails, please contact our company or dealer.

3. STRUCTURE AND PERFORMANCE

3.1 The Structure of the Power Wheelchair

This power wheelchair consists of the main part including the front wheel, drive wheel, frame, joystick, motor with mechanism, armrest, push handle, backrest, seat base, footrest, battery case, the structure shown in Figure 1.

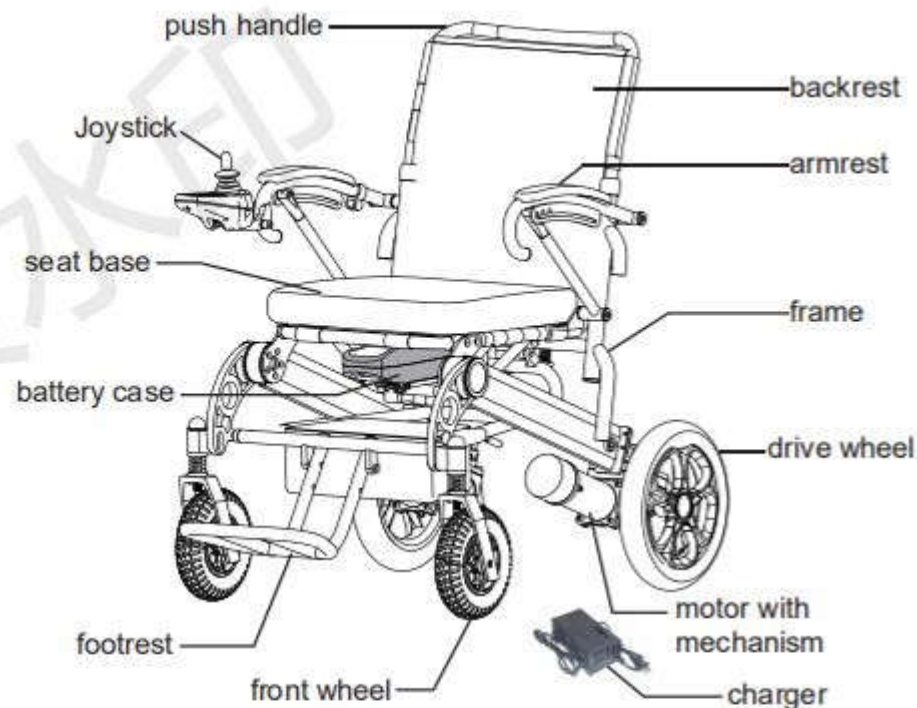
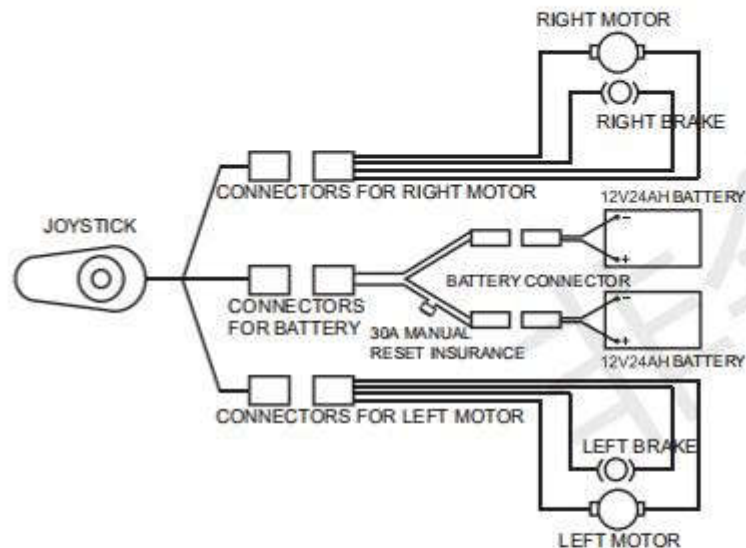

fig.1

3.2 Product Characteristics of the Power Wheelchair

- Classification by anti-shock type: wheelchair is internal power supply;
- Classification according to the degree of anti-shock: wheelchair belongs to the B-type application part;
- Classification according to the degree of protection of the feed: IPX0;
- Safety degree when used in flammable anesthesia mixed with air or flammable narcotic with oxygen or oxidized nitrogen Category: Non-AP or APG equipment;
- By operating mode: continuous operation;
- Rated voltage and frequency of wheelchair: DC 24V;
- Input power of wheelchair: internal power supply equipment;
- Whether the wheelchair has a protective effect on defibrillation effect: No;
- Whether the wheelchair has a signal output and input part: No;
- Permanent installation of equipment or non-permanent installation of equipment: mobile devices.

3.3 ELECTRICAL DIAGRAM OF POWER WHEELCHAIR



3.4 Product Software REV.

Controller version of power wheelchair W5521 is V1.6.

4. SPECIFICATION.

Sheet 1

Overall Dimensions(L*W*H)	1090mmX620mmX1020mm
Seat Height	500mm
Seat Width	430mm
Seat Depth	420mm
Armrest Height	240mm
Seatback Height	540mm
Battery Weight	1.8kg
Wheelchair Weight	29kg
Maximum Speed	≤6km/h
Braking Distance	≤1500mm
Minimum Turning Radius	≤1200mm
Weight Capacity	120kg
km Theoretical Travel Ranging	≥10km
Static Stability	≥9°
Dynamic Stability	≥6°
Slope Performance	≥9°
Climbing Ability	≥6°
Motor Type	24V/200W
Battery Type	24V10AH
Max. Output Current of Controller	50A
Max. Output Current of Charger	2A
Front Wheel	Inflate-free tire; Outside size 200mm
Rear Wheel	Inflate-free tire; Outside size 300mm

5. INSTALLATION, FOLDING AND DEBUGGING

5.1 Installation

- 5.1.1 Take out the chair from package to the ground, pulling it out forward and backward with one hand on the backrest and another on the bottom pole.(see fig.1)
- 5.1.2 Install the joystick on the armrest(Fig.2); Press down the spanner(Fig.3); to fasten the joystick(Fig.3).
- 5.1.3 Connect the battery plug into the frame socket.(Fig.4)
- 5.1.4 Press the switch limit of anti-tipper, pull out wheel(Fig.6) for the limit being into one of the three slots automatically.

5.1.5 Complete the installation by buckling the locker down(Fig.7)and then the chair is ready for driving.

5.1.6 The method for taking-out battery(Fig.8): unplug the aerial socket, press ① by hand, and then pull out the battery easily.



fig.1



fig.2



fig.3



fig.4



fig.5



fig.6

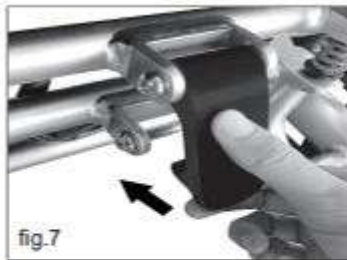

fig.7

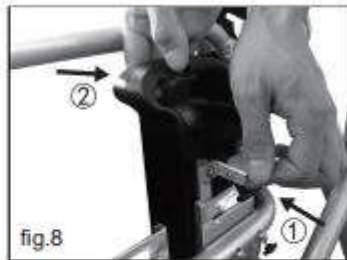

fig.8

5.2 Folding

The wheelchair can be folded to reduce the volume for transportation and storage.



fig.9

5.2.1 Turn off the power supply.

5.2.2 Pull up the locker(Fig.9) ,fold the chair with one hand on the backrest and another hand on the bottom pole.(Fig. 10), and then flip up the footrest(Fig.11).



fig.10



fig.11

5.3 Adjustment

5.3.1 When the brake levers are put outward to the manual position, the wheelchair can be pushed by hand; when they are on the electric position, the wheelchair can not be pushed by hand.

5.3.2 Press on the power switch of the controller, and then the battery indicator will light.

5.3.3 Rotate the joystick to the right forward, observing the wheels running, and then turn the joystick to the other directions to check if the wheels moving or not.

5.3.4 Release the joystick which will be recovered to the middle position. At the moment, observe the wheels which should stop running.

6.USING AND OPERATION

6.1 Using

6.1.1 Controller: an absolutely necessary electrical device. All electronic components to operate the wheelchair are integrated to the device. (See Figure 12) Usually, the controller is installed on an armrest, connected together with the motors and batteries to the power box.



- Switch button: Switch button supplies the power for control system for electronic equipment, then equipment supplies the power for motor of wheelchair. Do not use the switch button to stop the wheelchair unless an emergency situation. Otherwise it may shorten the life of the wheelchair drive components.

- USB: For charging daily used small appliances such as mobile phones, small fans.

- Joystick: The joystick is mainly used to control the wheelchair's movement including its speed and direction (forward, backward and left or right etc). The further you push the joystick from its central position, the faster the wheelchair moves. Whenever you release the joystick, it will automatically go back to the center and the brake will be automatically operative to stop the wheelchair.

- Horn button: The horn will sound if you press this button.

- Speed Up/Down Buttons and Speedometer: After turning on the power, the speedometer shows the current maximum speed setting. This maximum speed setting can be adjusted through the speed up button or speed down button by the user.

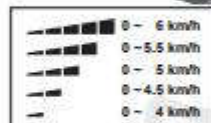

WARNING

If your wheelchair moves accidentally, please immediately release the joystick and pull up the manual brake. (fig.13)

- Charger Socket: It is only used to this wheelchair. Do not use the socket to supply power to any other electrical equipment. Otherwise, it may damage the wheelchair's control system or its E.M.C performance (Electromagnetic tolerance).



ATTENTION

If you connect any devices other than the supplied battery charger into the socket, causing damage to the control system, then the warranty is invalid.

6.1.2 Batteries and Its Usage

Fully charge your new battery prior to its initial use. This brings the battery up to about 90% of its peak performance level; Give the battery another full charge of 8-14 hours and operate your wheelchair again, the batteries will now perform at over 90% of their potential; After four or five charging cycles, the batteries will top off at 100% charge and last for an extended period. Please replace a new battery when there is a battery failure, and the old battery must be returned to supplier because of environmental pollution.



CAUTION

Do not use your wheelchair when the temperature is below -25°C or above 50°C . (Fig.6)

6.1.3 Charging Batteries

The battery charger is an important part of the wheelchair. The off-board charger attached to this product can charge its batteries quickly and easily to make your wheelchair the best.



CAUTION

The charger of 24V/2A supplied by our company meets the requirements mentioned in Section I («General Safety Requirements») of medical electrical equipment GB9706.1-2007. The battery must be charged by the charger supplied by us. Any other types of chargers are forbidden.

Please note below tips when charging:

- Be certain the controller is powered off and the wheelchair is in the drive mode, instead of the manual mode.

- Connect the 3-pin output plug of the charger to the controller. (Fig.15)

- Connect the power plug of the charger to the standard wall outlet.

- The red LED on the charger lights indicates that charging is in progress. The green LED on the charger lights when the batteries are fully charged.

- We recommend you that the batteries are charged for 8-12 hours.

- Remove the charger and power plug when fully charged, and put them into the bag behind the seat rest.

6.1.4 Safety Belt

For your safety, the safety belt must be fastened before you drive the wheelchair. (fig.14)

**WARNING**

Never get the batteries frozen, neither charge the frozen batteries, otherwise it may lead to personal injury and damage to batteries.

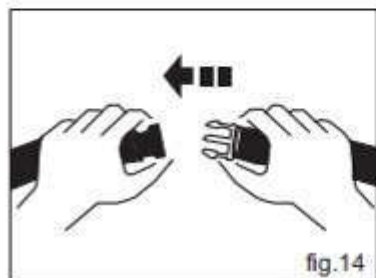

fig.14



fig.15

6.2 Operation**6.2.1 Preparation before operation**

- Do not turn on the power switch when sit on the power wheelchair, and do turn off the power switch when get off from the wheelchair. Please observe whether the hand brake works or not.
- Please fold the pedal first then hold the armrest to sit on the wheelchair; Do not get off the wheelchair by stepping on the pedal. Otherwise the wheelchair maybe turned over, which is dangerous.

6.2.2 Practice before operation

- Find a spacious place like square and have a assistant to help you practice until you have enough confidence to operate it.
- Be certain to shut down the power when you up and down the chair, and set a speed you need through speed adjustment button.
- We recommend you set the lowest speed until you can operate the electric wheelchair skillfully. (fig.7)
- To Practice the stop operation, forward and backward. Push the handle, the wheelchair move to anywhere you want.(fig.8)
- Firstly, ensure that it is the lowest speed when practice forward operation. After Skilled, you can practice "S" shaped turn. After you are familiar with "S" shaped turn, to practice backward operation, and pay attention to the speed control setting. And the backward speed should lower than forward speed.(fig.9)

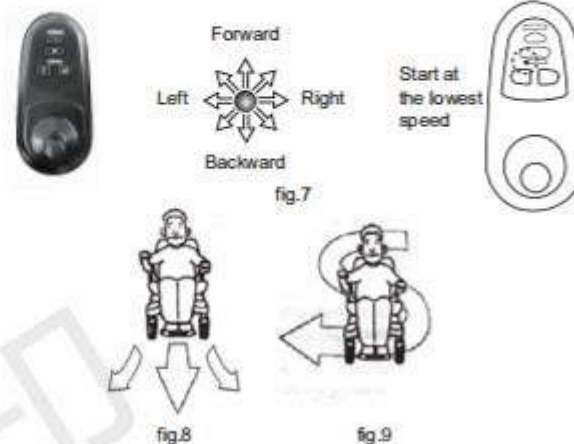

fig.7

fig.8

fig.9

6.2.3 Operation

Please do it according to precautions operation.

7.FAULT DIAGNOSIS AND TROUBLESHOOTING

This product has an automatic fault warning function to give you very convenience. Once it malfunctions, the LEDs on the controller will flash with alarm sounded by the horn. You can find where a fault is according to information in Table 2. If the fault still exists after checking out the fault based on that in table 2, Please consult your service agent immediately.

Table II

LED display	Fault Diagnosis	Troubleshooting	Remark
1 LED lamp flashes	Battery is of low	charging	
2 LED lamp flashes	The left motor failure	Check the motor and wiring harness	
4 LED lamp flashes	The right motor failure	Check the motor and wiring harness	
6 LED lamp flashes	Overload of the controller	Check if the brake is released, or wheels are locked.	
7 LED lamp flashes	Failure of the joystick	Check if the rocker of controller in the central position	
8 LED lamp flashes	Failure of the controller itself	Controller fault	
9 LED lamp flashes	Failure of the controller	Controller fault	

8.SAFETY DEVICES AND ACCIDENT TREATMENT

8.1 Overload Protector: Refer to instruction manual 6.1.4

8.2 Safety belt: Refer to instruction manual 6.1.6

8.3 Please release the joystick whenever there is a wheelchair fault , the wheelchair will be stopped.

9.MAINTENANCE AND REPAIR

9.1 Maintenance

Like other motorized vehicle, your power wheelchair also requires routine maintenance. Some checks can be performed by yourself, others you can ask for assistance from your service agent. Preventive maintenance is very important. If you follow the maintenance and checks in this section, your wheelchair will give you years of trouble-free operation. If you have any doubt your wheelchair's care or operation, please contact your service agent or our after-sale service dept.

9.1.1 Humidity

Your wheelchair, like most electrical and mechanical equipment, is susceptible to external conditions. In any case, the wheelchair should be avoided damp environment. Direct or prolonged exposure to water or dampness could cause the wheelchair to malfunction electronically and mechanically. Water can cause electrical components and the wheelchair's frame to corrode.

9.1.2 Temperature

- Some parts of your wheelchair are susceptible to temperature.
- In extremely cold temperature, the battery may be frozen. Special temperatures may cause a lot of factors to freeze, like charger type, usage, battery components (such as sealed lead-acid batteries or gel batteries);
- Temperature above 55° may cause the deceleration of your wheelchair.

9.1.3 General Guidelines

- Avoid beating the controller, especially the joystick.
- Avoid prolonged exposure of your wheelchair to extreme conditions, such as hot, cold or moisture environment.
- Keep the controller clean.
- Check all electric connections, including the cable and connectors of the charger, and ensure that they are all tight and secure.
- If only red LEDs on the Battery Gauge lights, the batteries are nearly running out of charge. You should recharge the batteries as soon as possible. We recommend charging the battery for 8-12 hours
- Check the rear wheel inflatable situation, if the tire deformed serious when riding , it should be inflated;
- The frame surface has been sprayed with a clear sealant coating. You can apply a light coat of car wax to make the surface keep a high gloss.

- Check all cable connections. Make ensure they are fastened and are not corroded. The battery must be placed in the battery area, flat, the battery plug inward, relative display, refer to the correct connection on the main frame label;
- All wheel bearings are lubricated and sealed. Do not need to lubricate them.
- Check if there is loose phenomenon for wheel hub, drive device, and chair itself, if loose, please screw tightly in time.



WARNING

Please be sure the tire pressure is within 230KPa±10%. Please inflate the tires with regulated air source and check with pressure gauge. Do not exceed the pressure range, otherwise may cause exploded tires or personal injury.(fig.11)

9.1.4 Maintenance after use

- Turn off the power(please disconnect all the connectors if not use for long time.)
- Inhibit children and unconscious persons to use the wheelchair.
- Store the wheelchair in normal temperature to prevent reformation so that it keeps its performances for long period.
- Clean the wheelchair with a clear and soft cloth and dry it. Never use any chemicals to clean it.(to prevent deformation and discoloration).
- Remove the cloth cover of the seat rest to be washed if it is dirty, and then dry it for use.

9.1.5 Daily Checks

In order to keep the wheelchair in good condition, you should check before each use. And to maintain the weekly, monthly, semi-annual investigation, check the project see (Table III).

Table III

Inspection Items	At any time	Weekly	Monthly	Six monthly
Wheel hubs, Driving mechanism and fasteners			○	
Joystick function	○			
Brake System	○			
Connection		○		
Battery Condition	○			
Tire Condition			○	
Inflation condition of rear wheels	○			
Frame Condition				○
Motor and actuator condition				○
Front Wheel Condition		○		
Pureness	○			



CAUTION

In order to guarantee the quality of power wheelchair, Please contact us or our dealers to replace the spare parts with same models and specifications if the consumable parts like batteries, tyres, controller, motors and charger, etc. need to be replaced. The maintenance should be proceeded at our corporation or the dealers' maintenance dept.

9.1.6 Cleaning

Way of cleaning as below.

Clean the wheelchair with dry cloth.



- Never wash your wheelchair with water or expose directly to water.
- Surface of wheelchair frame is coated with a protective coating. Therefore, it is very easy to wipe it clean with a damp cloth. Never use any chemicals to clean the vinylon seat and armrest, as they may cause the latter slip or chapped. You can use a damp cloth and neutral soapy water to clean them, and then dry thoroughly.

9.2 Repairment

9.2.1 Users could repair or replace some spare parts like push handle, push handle cover which could be self-maintained or replaced by users under the instructions of after-sales service staff of our corporation or the dealers'.

9.2.2 Within the warranty, our corporation or the dealers will maintain or replace the faulted spare parts, like motor, battery, charger, controller, bearing, shaft sleeve, etc., due to material or manufacturing defects free of charge.

9.2.3 The spare parts like motor, controller, etc. which are confirmed by the after-sale staff or our corporation or our dealers' to be dissembled could be sent to our corporation or the dealers for maintenance.

9.2.4 Please contact your distributor or the after-sale service dept. of our corporation for any questions regarding the maintenance of power wheelchairs. Please refer to 12.1 Product Warranty.

10. TRANSPORTATION AND STORAGE

10.1 Transportation

You can load and transport according to the shipping marks and graphics. For details, see the attachment.

10.2 Storage

Your wheelchair should be stored in a clean indoor environment with relative humidity $\leq 80\%$, good ventilation and free from corrosive gas. Remove the batteries from the wheelchair prior to storage. Otherwise, the frame may rust and the electronics may be damaged.

11. OPENING AND CHECKING

The packing list is attached in the package. Please check if any parts missed or damaged.

NO.	Name	Quantity	Remarks
1	Power wheelchair	1	Model: W5521
2	Charger	1	Model: AC100-240V 50/60HZ 24V2A
3	Manual	1	
4	Pedals	2	
5	controller	1	

12. QUALITY ASSURANCE

12.2.1 5-year warranty service for chair frame.

12.2.2 Within 12 months from the purchase date, for the following parts, we will supply free maintenance and replace service for original customer after the dealer check there are materials and production defect.

- Electrical control or lever system
- Motor/Drive System
- Bearing and shaft sleeve









12.2.3 12-Month warranty for the batteries.

Please note the warranty service is provided by your dealer, and finally finished by our after-sales department and dealer together.

Out of warranty

- ABS plastic cover shell and rubber pad
- Tyre
- Interior decoration
- Damage by abuse, wrong operation, accidents and negligence
- Damage by wrong operation, maintenance and storage.
- Business use or other abnormal use

The name and symbols of the signs

No.	Sign	Meaning
1		Fragile objects inside the packaging, please handle with care.
2		Keep the packaging up during transportation.
3		Keep the packaging avoid from rain
4		The max. layers of stacking same packaging is 2.
5		Hand hook are forbidden when carry on transport the packagings
6		Application type B.
7	IPX1	Plummeted Droplets (condensed water for example do not damage the electrical appliance)
8	 	Warning. Attention. Caution.

