



**DAWNHOUSE**



# DAWN HOUSE BED | OWNER'S MANUAL

Customer Service: [www.dawnhouseliving.com](http://www.dawnhouseliving.com) | 1-888-DAWNHSE (1-888-329-6473)

Actual product appearance and functionality may vary from photographs, illustrations and descriptions included in this manual.

# TABLE OF CONTENTS

Safety Precautions and Usage Statements .....	1-3
Parts List .....	4
Base Overview .....	5
Electronic Overviews .....	6-8
Installation Guide .....	9-10
Dawn House Headboard Installation .....	11
Placing the Bed into Your Own Furniture .....	12
Remote Control .....	13
Pairing the Remote Control .....	14
The Puck Voice Activated System Overview .....	15
The Puck Voice Activated System Installation .....	16
The Puck Voice Commands .....	17
Syncing Two Twin Long Bases (Optional) .....	18
Emergency Battery Backup Strap .....	19
Troubleshooting .....	20
Notes .....	21

For customer support, visit [www.dawnhouseliving.com](http://www.dawnhouseliving.com) or call: 1-888-DAWNHSE (1-888-329-6473)

# SAFETY PRECAUTIONS AND USAGE STATEMENTS

## ATTENTION: IMPORTANT SAFETY DISCLAIMERS

READ THE FOLLOWING INFORMATION BEFORE USING THIS PRODUCT. FAILURE TO USE A SURGE PROTECTION DEVICE COULD COMPROMISE SAFETY OR CAUSE PRODUCT MALFUNCTION AND COULD VOID THE ELECTRICAL PORTION OF YOUR WARRANTY.

### TO REDUCE THE RISK OF SHOCK, BURNS, FIRE OR INJURY:

For optimal safety and operation, plug bed base into a surge protector (not included). The bed base should only be plugged directly into a wall outlet or surge protector (strongly recommended). Always unplug the base from the electrical outlet before servicing any part of the base. To reduce risk of electric shock, unplug the base before cleaning. To safely disconnect, ensure the base is in a flat position with all motors off, and unplug from power source. Keep the power cord away from heated surfaces. Never operate the base when the air openings are blocked. Keep air openings free of lint, hair and the like. Do not drop or insert any object into any opening. Discontinue use of the bed base and contact a qualified service center if: it has a damaged cord or plug, if it is not working properly, or it has been dropped into water. Only use this bed base for its intended use as described in this manual. Do not use accessories/attachments that are not recommended by the manufacturer. Close supervision is required when the bed base is used by or near children, convalescents, disabled persons or pets. Improper connection of the equipment can result in the risk of electrical shock, electrical fire or faulty operation of this bed base. If the plug does not fit your outlet, contact a qualified electrician to install a suitable outlet. Unauthorized modification or failure to use a wall outlet or surge protector could void the electrical portion of your warranty.

### CHILDREN AND PETS:

Immediately dispose of all packing materials as it may pose a smothering risk to small children and pets. To avoid injury, it is not advised to allow children and small pets to play on or under the bed. Children should not operate the bed base without adult supervision.

### SAFETY FEATURES:

Manual operation – If something gets caught in the platform when flattened, you can manually raise the platform up by lifting at either the

head or foot to relieve pressure and allow for release.

Emergency stop – Stop the motion of the platform by pressing any button on the remote control.

Power outage – Use the “Emergency Battery Backup Strap” as a temporary power source to get the base to a desired position.

Instructions on how to operate the Battery Backup Strap are on the Emergency Battery Backup page(s).

### PACEMAKERS:

Some products contain Neodymium MAGNETS which may interfere with devices such as pacemakers, ICD's and any other device sensitive to magnetic fields. It is STRONGLY recommended that owners of such medical devices consult their physician prior to using products that contain Neodymium MAGNETS. It is also possible that some pacemakers may falsely interpret the optional massage feature vibrations as movement/exercise. This is a common occurrence with any product that creates a vibrating movement and may affect the pacemaker. Please consult your physician before using the massage feature.

### IN-HOME USE AND HOSPITAL STANDARDS:

Ergo adjustable bed bases are designed solely for in-home use. This base was not designed as a hospital bed and is not designed to meet hospital standards. Do not use this base with TENT TYPE oxygen therapy equipment or near explosive gases.

### ADDITIONAL SAFETY FEATURES

Casters (optional leg accessory) are equipped with locking wheels to prevent unwanted movement. Even when locked and unable to roll, it is possible for the casters to slide. Free release head and foot motors are designed to lower the mattress by retracting only with gravity, never pulling downwards, which minimizes pinch points

# SAFETY PRECAUTIONS AND USAGE STATEMENTS

## LIFTING/LOWERING MECHANISMS

The lift/lower feature will emit a minimal humming sound during operation. This is normal. During operation, the lift arm wheels make contact with the platform support of the base. This contact may result in metal on metal or metal on plastic contact. This applies slight tension on the moving components and resonance is reduced to a minimum level. If excessive noise or vibration is experienced, reverse the movement action (up or down) of the base with the remote control. This should realign the base's activating mechanisms to the proper operational position. In normal base operation, the wheels, which allow the bed to maintain its distance from the wall, will make contact with the steel platform supports of the base creating a contact noise. When entering, exiting or shifting weight on the base, this contact noise may be audible as the wheels make contact. This is normal.

## MATERIALS

Ergo adjustable bases are constructed from various materials including woods, metals, plastics and fabrics. Tension, pressure or movement applied to the frame, platform or shroud through general use may create an audible sound.

## MESSAGE OPERATION AND LOCATION ENVIRONMENT

The massage feature will emit a tone during operation. This is normal. As the massage intensity level is increased, the tone will intensify. The volume of this tone is directly related to the location environment. For example, when demonstrated in a show room, the surrounding environmental noise will cover some of the massage noise. However, when installed in a home setting with wooden floors, carpeted or not, the massage volume will be more noticeable. To minimize this resonance, place a piece of carpet, or rubber caster cups, under each leg or caster of the base. It is possible to experience vibration or noise from the exterior bed frame, headboard brackets, headboards or footboards if mounting bolts are not firmly tightened.

Levels 1-3 of massage intensity represent the revolutions of the motor per minute. Level 3 provides the maximum number of RPMs. However, this does not mean that the feeling of vibration is the strongest. Depending on the mattress material, thickness, and positioning of the

user, the feeling of vibrations will differ. We encourage the user to find the massage intensity setting that suits them best. It is important to understand the physics of vibrations. Just as an engine may run rough during idle, as the RPMs increase, the vibrations change concurrently.

## TOLERANCE

All Ergo adjustable foundations, depending on make and model, are designed and manufactured to perform and function within designated quality control parameters. Bases are subject to meticulous and rigorous inspections during the quality control process to ensure bases will operate within these standards during normal operating use. Normal operating use is defined as the following: Adjustable foundation is to be operated with a mattress and load. Testing procedures require lifetime cycle tests with up to 120kg distributed load. The angle (designated "α" in figure 1) between the back section and the flat section for various configurations of the mattress support platform shall be  $\pm 3^\circ$ , which translates to a tolerance of up to  $1\frac{1}{2}''$ .

The angle (designated "β" in figure 1) between the flat section and foot section for various configurations of the mattress support platform shall be  $\pm 3^\circ$ , which translates to a tolerance of up to  $\frac{3}{4}''$ .

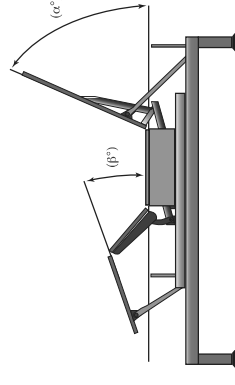

Any adjustable foundation deemed to be within these allocated tolerances is considered to have met the manufacturer's quality control standards.

## THAT "NEW PRODUCT" SMELL:

Some people notice a slight odor to their new adjustable base—this can come from our material manufacturing process. This smell is normal and usually disappears before the product reaches you. Sometimes, however, this smell may still be noticeable. It usually disappears after a few weeks, providing adequate ventilation of the product and the environment.

# SAFETY PRECAUTIONS AND USAGE STATEMENTS

## **BREAK IN PERIOD:**

You can speed up the break-in period by simply spending time in the adjustable bed through activities such as reading, watching TV or playing with the kids or grandkids. The extra movement will help the adjustable base respond to weight and temperature changes. Some of the materials in our adjustable bases such as the woods, metals and plastics used in the platform, frame and components are sensitive to moisture content and temperature and may make sounds in colder environments.

## **PAIRED OPERATION:**

When operating a “paired” split base setup there may be a time latency up to 1.5 seconds between each bases articulation.

## **WEAR AND TEAR:**

Wear and tear is damage that naturally and inevitably occurs as a result of normal use or aging.

## **FABRIC CARE:**

To prolong the life of your fabric, protect from direct sunlight whenever possible. For spot cleaning, wipe area with a light damp sponge or vacuum with a soft brush attachment to remove particles. Keep at a minimum of 30cm (12 inches) away from direct heat sources. For a deeper cleaning, blot liquid spills with a clean dry cloth. Wipe with a clean cloth dampened with warm water. Do not wet excessively. A soft bristle brush may be used to remove ingrained soil. Avoid scratching by gentle brushing. Wipe with a clean cloth dampened with warm water to remove residues. Dry in shade away from direct heat. If persistent marks remain visible after cleaning, seek professional advice.

## **PRODUCT RATINGS:**

The lift motors are not designed to operate continuously for more than [2] minutes in an [18] minute time period or approximately 10% duty cycle. Attempting to circumvent or exceed this rating will shorten the life expectancy of the product and may void the warranty. The message motors are not designed to operate continuously for more than 30 minutes at a time. Please allow the massaging system to rest for 30 minutes after automatic massage shut off before restarting.

## **WEIGHT LIMITS:**

This product is not rated to support weights in excess of 750 pounds for Queen/Full sizes and 450 pounds for TL sizes. The base will structurally support this weight, provided it is evenly distributed across the bed base. The adjustable base is not designed to support or lift this amount in the head or foot sections alone. Exceeding this weight restriction could damage the bed and/or cause injury and will void the warranty.

## **SAVE THESE INSTRUCTIONS.**









## **FCC COMPLIANCE:**

**NOTE:** This equipment has been tested and found to comply with the limits for a Class B digital device, pursuant to part 15 of the FCC Rules. These limits are designed to provide reasonable protection against harmful interference in a residential installation. This equipment generates, uses and can radiate radio frequency energy and, if not installed and used in accordance with the instructions, may cause harmful interference to radio communications. However, there is no guarantee that interference will not occur in a particular installation. If this equipment does cause harmful interference to radio or television reception, which can be determined by turning the equipment off and on, the user is encouraged to try to correct the interference by one or more of the following measures:

- Reorient or relocate the receiving antenna.
- Increase the separation between the equipment and receiver.
- Connect the equipment into an outlet on a circuit different from that to which the receiver is connected.
- Consult the dealer or an experienced radio/TV technician for help.

# PARTS LIST

BEFORE DISCARDING THE PACKING MATERIALS - ENSURE ALL THE PARTS ARE ACCOUNTED FOR. ALL ELECTRONICS AND COMPONENTS THAT NEED TO BE INSTALLED ARE LOCATED IN BOXES UNDER THE BASE OR ATTACHED TO THE FRAME.

<p>A</p> 	<p>B*</p> 	<p>C</p> 	<p>A. Wireless Remote Control &amp; AAA Batteries (2) B. Mattress Retainer Bar*</p>
<p>D</p> 	<p>E</p> 	<p>F ‡</p> 	<p>C. Legs Pads (4) D. Power Cord E. Power Supply F. Sync Cord ‡</p>
<p>G</p> 	<p>H</p> 	<p>I</p> 	<p>G. Battery Backup Strap (2) 9V Batteries (not included) H. Puck Voice Activated System I. Input Cord</p>

## MISC PARTS RECOMMENDED (NOT INCLUDED):

Surge Protector

\* These items are attached to the base for shipping purposes. Carefully remove from base and set aside.

‡ Only included in Twin Long and Cal King Split bases.

# BASE OVERVIEW

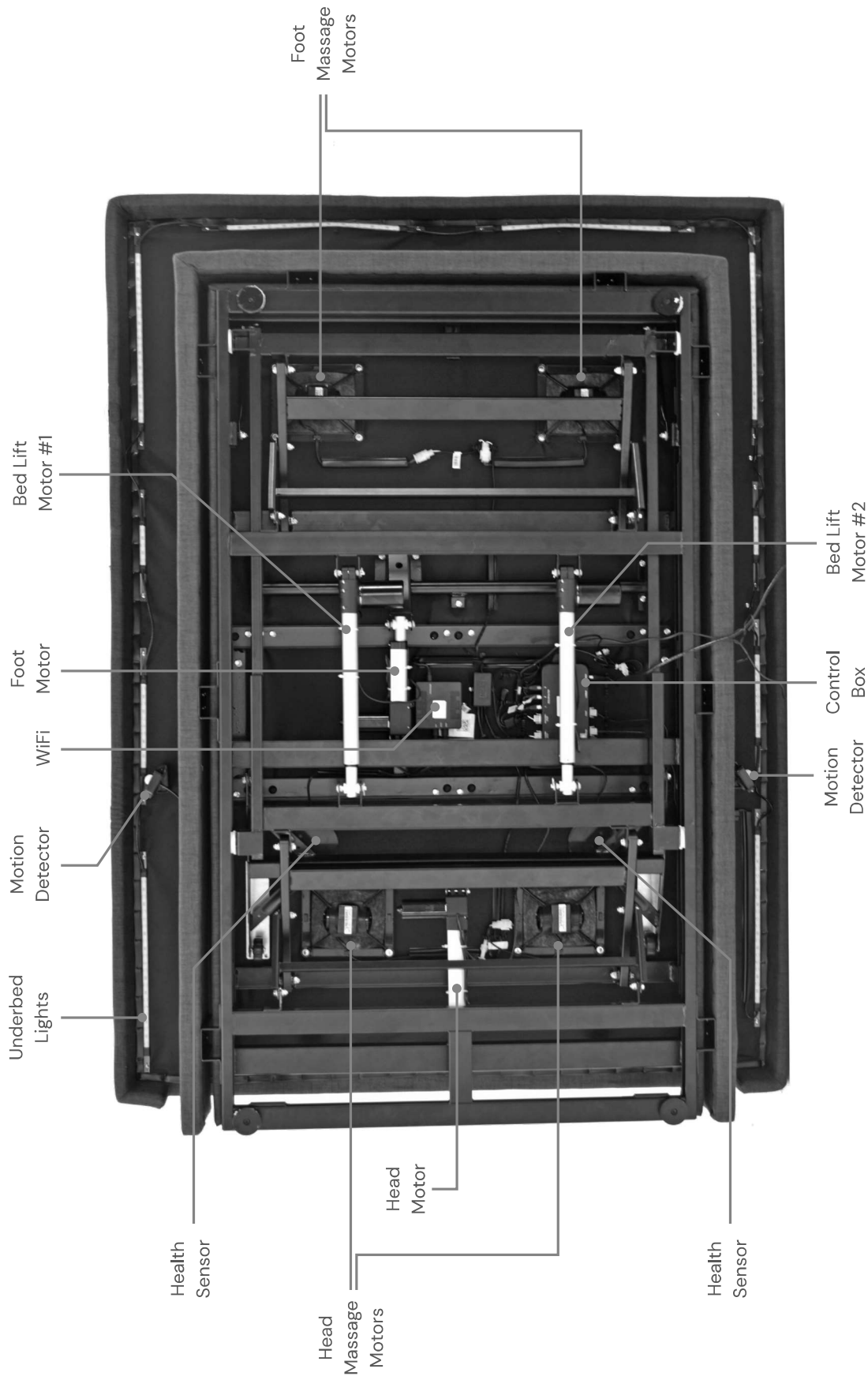

# QUEEN SIZE ELECTRONIC OVERVIEW

NOT TO SCALE. FOR ILLUSTRATION PURPOSES ONLY. READ ALL INSTRUCTIONS BEFORE BEGINNING INSTALLATION.

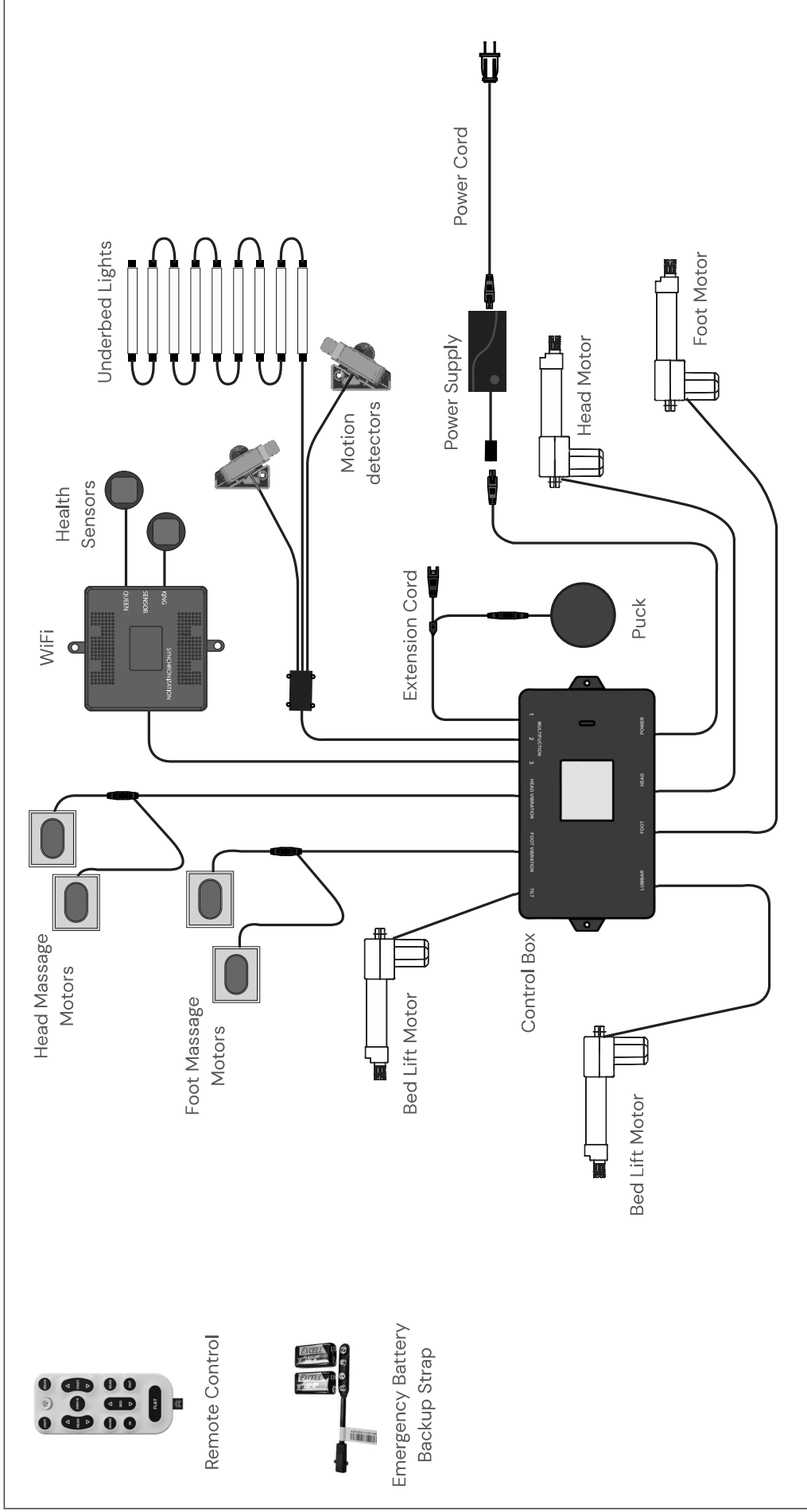



# TWIN LONG SIZE ELECTRONIC OVERVIEW

NOT TO SCALE. FOR ILLUSTRATION PURPOSES ONLY. READ ALL INSTRUCTIONS BEFORE BEGINNING INSTALLATION.

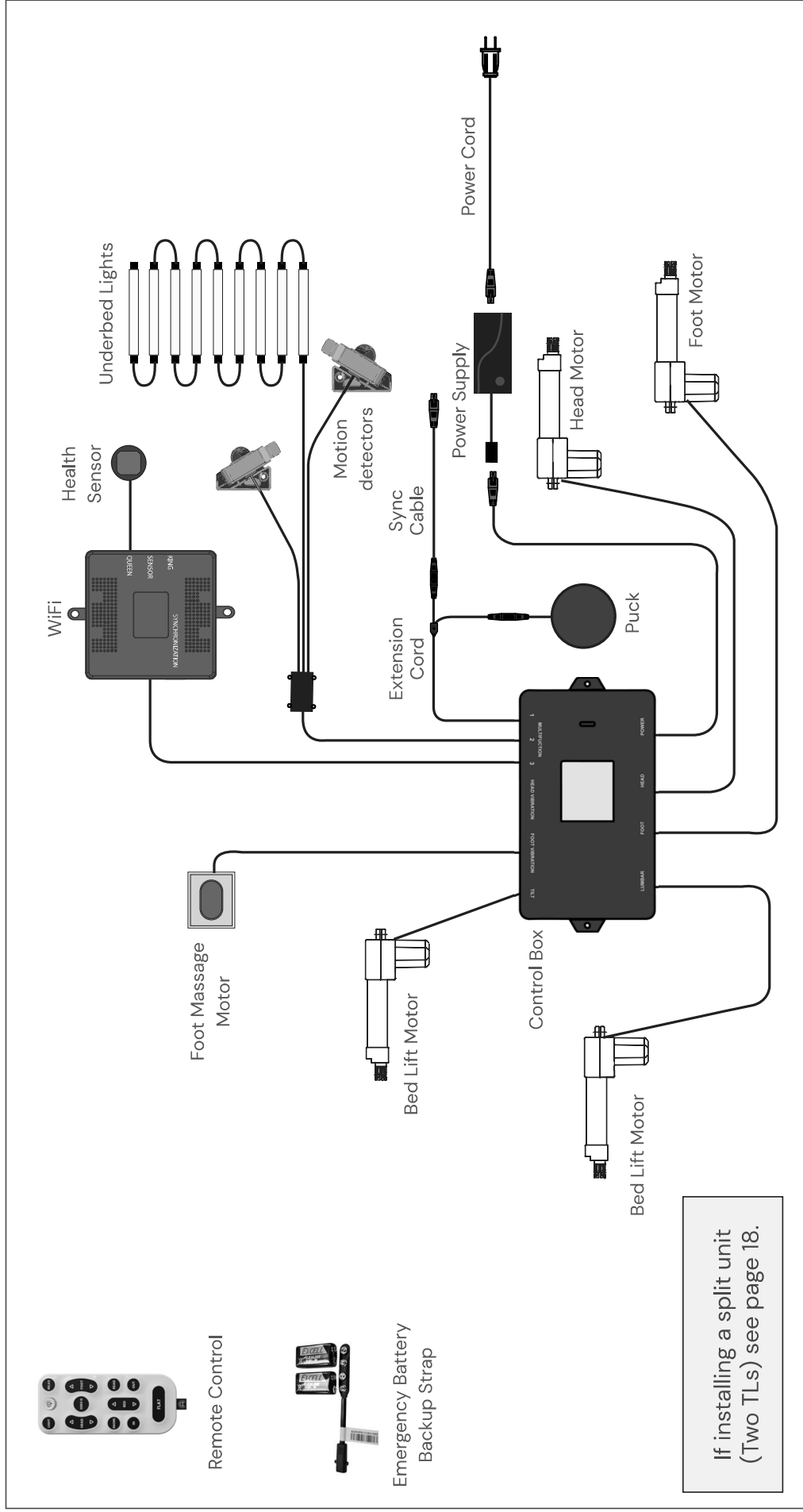

# FULL SIZE ELECTRONIC OVERVIEW

NOT TO SCALE. FOR ILLUSTRATION PURPOSES ONLY. READ ALL INSTRUCTIONS BEFORE BEGINNING INSTALLATION.

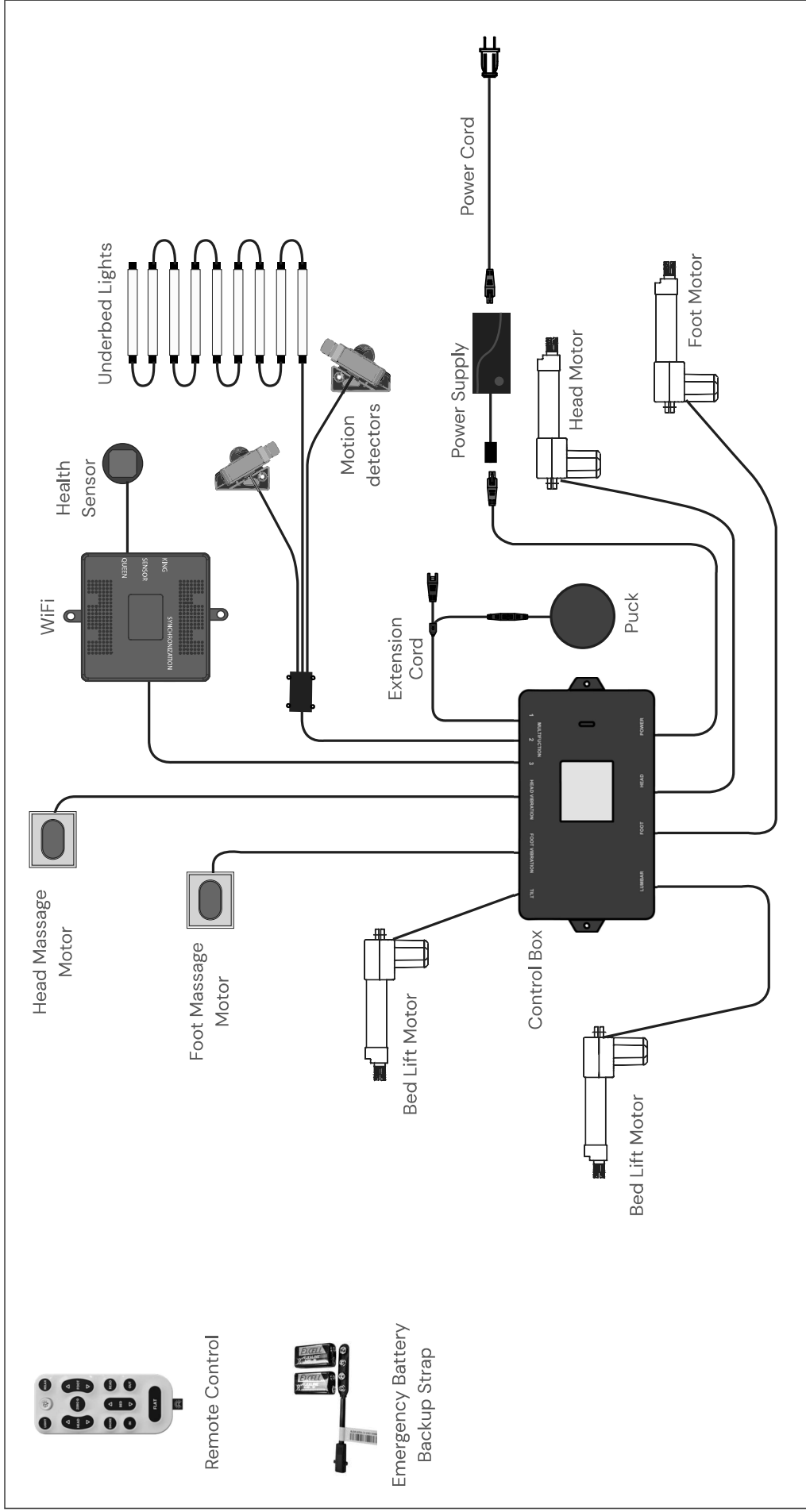

# INSTALLATION GUIDE

**ALWAYS USE TWO PEOPLE WHEN SETTING UP THE BASE.**

## STEP 1

With the help of an able-bodied assistant, place the carton on the floor in its desired location with the bottom side facing up. Remove all tape and binding straps, being careful not to puncture the box with any sharp objects.

## STEP 2

Open the box and remove the plastic bag. Cut the zip ties and set aside any accessories and electronics. Ensure that all items from the parts list on page 4 are set aside before proceeding to Step 3.

## STEP 3

Screw in the leg pads on all four corners of the frame.



## STEP 4

Using two people, carefully flip the base to an upright position and move it to its desired location.

## STEP 5

To install the mattress retainer bar, insert each end of the bar into the holes at the foot of the base. Rotate the bar so that it is resting on the edge of the base.

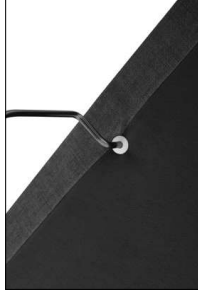

## STEP 6

Plug the Puck wireless charger into the extension cord located on the underside of the bed at the head section. See pages 15-17 for more information.

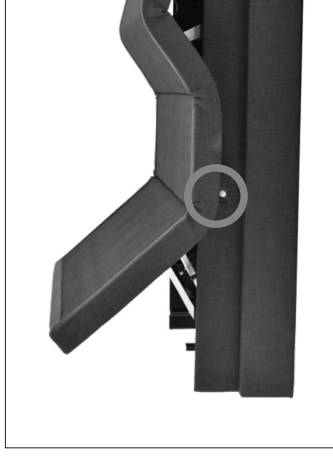

# INSTALLATION GUIDE (CONTINUED)

## STEP 7

Locate the input cord under the base and plug it into the power supply.



## STEP 8

Insert the power cord into the power supply.



## STEP 9

Plug the power cord into a power source. **A surge protector is recommended.**



## STEP 10

Install the remote batteries and test all functions to verify proper setup before placing mattress on base. Return the base to a flat position before placing the mattress on top.

## STEP 11 (Optional: For Dawn House mattress orders only)

If you received the Dawn House mattress with your order, remove it from its carton and and unroll the mattress. Carefully cut open the vacuum sealed packaging and place the mattress on the base.

## STEP 12

Download the Dawn House App from the App Store (Apple) or Google Play Store (Android). Follow the in-app instructions. To connect your base to the app, scan the QR code located under the head section of the adjustable base.

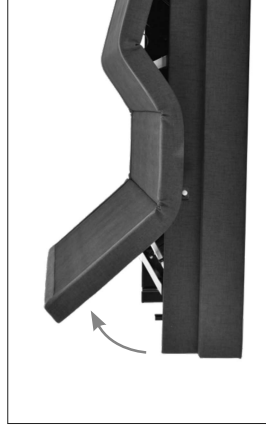

- ▲ To assemble the Dawn House headboard, proceed to the next page for installation.
- ▲ For instructions regarding the use of your own furniture, see page 12.
- ▲ If not installing headboard or placing in furniture, setup is complete.

# DAWN HOUSE HEADBOARD INSTALLATION

CONTINUE WITH THE STEPS BELOW TO INSTALL YOUR DAWN HOUSE HEADBOARD.

## STEP 1

With the help of an able-bodied assistant, place the headboard carton on the floor in its desired location. Remove all tape and binding straps, being careful not to puncture the box with any sharp objects.

## STEP 2

Open the box and remove the plastic bag. Be sure to locate and set aside any hardware.

## STEP 3

Use the remote control to raise the head of the adjustable base all the way. Unplug the power cord from the power source.

## STEP 4

Align the headboard to the headboard mounting points on the frame.



## STEP 5

Secure the headboard to the base with included screws. (At least two screws are needed per mounting point.)



## STEP 6

Feed the power cord through the hole in the headboard and plug it into the power source.



# PLACING THE BED INTO YOUR OWN FURNITURE

IF YOU HAVE A HEADBOARD OF YOUR OWN, A UNIVERSAL HEADBOARD BRACKET CAN BE USED TO MOUNT YOUR EXISTING HEADBOARD SAFELY AND SECURELY TO THE BASE. IF YOU HAVE AN EXISTING BED FRAME, OUR BED MAY WORK; HOWEVER, SOME KEY FEATURES MAY BE INCOMPATIBLE.

**WARNING:** Placing the Dawn House bed inside of an existing bed frame can cause pinch point and entrapment risks. Please thoroughly consider the risks before using your own bed frame.

## EXCEPTIONS:

- Our bed should not be placed on slats or box springs
- Our bed may require legs (sold separately) to be compatible with some 3rd party bed frames.\*
- Underbed lighting and motion activated underbed lighting will be hindered by 3rd party bed frames
- The Support Rail (sold separately) is incompatible with 3rd party bed frames.

\* If your bed frame is taller than Dawn House bed, 3" legs are offered (sold separately). Visit [Dawnhouseliving.com](http://Dawnhouseliving.com) to purchase.

## PLACING THE BED INTO YOUR OWN FURNITURE

The Dawn House bed is slightly narrower than the standard bed frame size and can work with most existing bed frames.

The bed is designed to rest on the floor, which will require the removal of box springs or slats from your current frame.

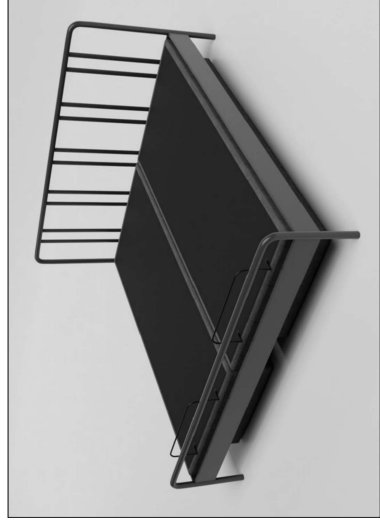
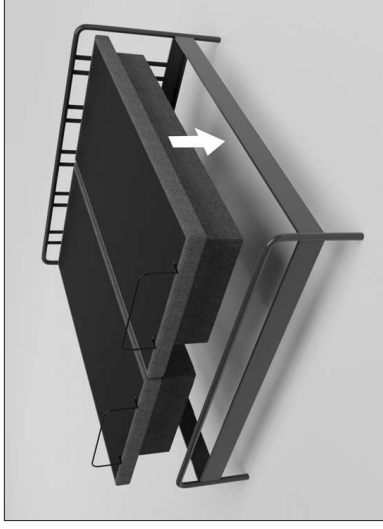

**MEASURING:** Smallest internal dimensions of the bed frame (with the mattress support removed) should be no less than:

- Twin Long – 37.5" x 81"
- Full – 53.5" x 75"
- Queen – 59.5" x 81"
- King/Split King – 75" x 81"

**Measurement tip:** If your existing mattress will sit on the floor inside of your current bedframe, then the Dawn House Bed should also fit.

# REMOTE CONTROL

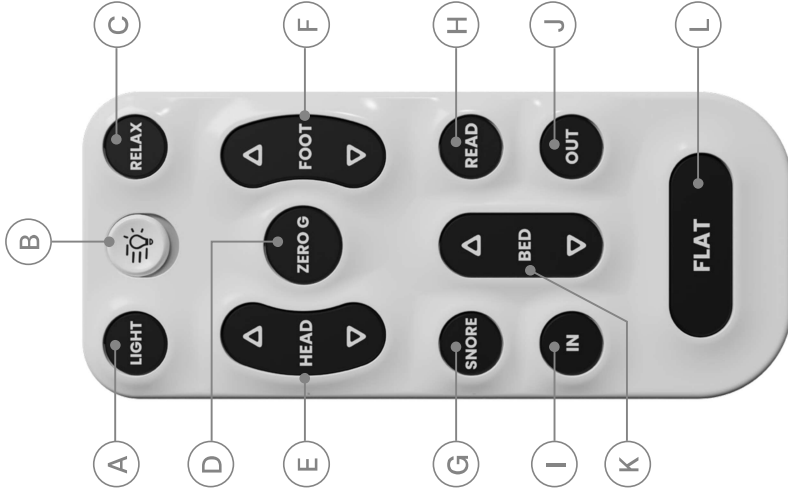

## BUTTON FUNCTIONS

- A. Light: Turn the underbed lights **On/Off**.
- B. Motion Detector Switch: Motion activated underbed lighting: **On(Up)/Off(Down)**  
*Note: Press the Flat button to confirm selection.*
- C. Relax: Massage cycle (**Low > Medium > High > Off**)  
After 10 minutes, massage timer will automatically turn off.
- D. Zero-G®: Preset position that adjusts your legs to a higher level than your heart helping to relieve pressure off the lower back and promote circulation.
- E. Head Articulation: Raises and lowers the head end of the adjustable base.
- F. Foot Articulation: Raises and lowers the foot end of the adjustable base.
- G. \*Anti-Snore: Programmable preset position raises the head section of the base slightly to help reduce snoring.
- H. \*Read: Programmable preset position ideal for reading a book or watching TV.
- I. \*\*In: Programmable bed-height preset position.
- J. \*\*Out: Programmable bed-height preset position.
- K. Bed: Raises and lowers the bed height.
- L. Flat: Return the adjustable base to a flat position.

**\*TO PROGRAM A NEW HEAD/FOOT ARTICULATION PRESET:** Articulate the head and foot to your desired position. Press and hold one of the preset buttons [**Snore, Read**] for 7 seconds. The position is now saved.

**\*\*TO PROGRAM A NEW BED HEIGHT PRESET:** Raise or lower the bed to your desired bed height. Press and hold one of the preset buttons [**In, Out**] for 7 seconds. The position is now saved.

**NOTE:** To restore the preset buttons back to their original factory settings, hold **FLAT** and **ZERO-G®** simultaneously for at least 5 seconds. The original presets will be restored.

Download the Dawn House app for an in-app remote control tutorial.

# PAIRING THE REMOTE CONTROL

THE REMOTE THAT COMES IN THE BOX IS ALREADY PAIRED TO THE ADJUSTABLE BASE. NO FURTHER ACTION IS REQUIRED. IN THE EVENT THAT THE REMOTE IS NOT PAIRED WITH THE BASE, FOLLOW THE STEPS BELOW.

## STEP 1

Disconnect the base from its power outlet. Wait 10 seconds, then plug it back in.

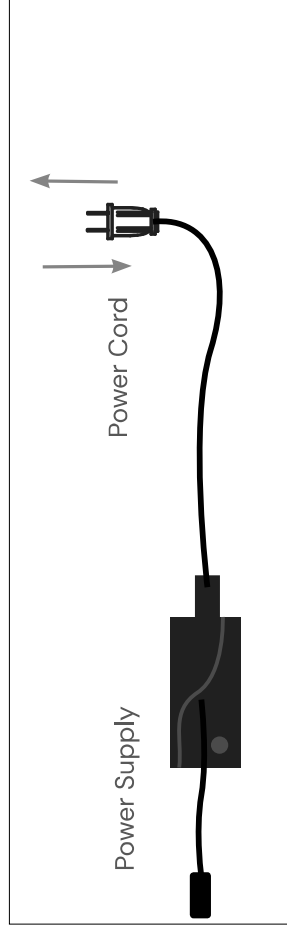

## STEP 2

Remove the battery cover on the back of the remote control. Press and hold the PAIR button for about 5 seconds until the PAIR button stops flashing. Once it stops flashing, the remote has been successfully paired.



## STEP 3

Test all remote functions. If the remote buttons do not impact the adjustable base movements, please repeat the process again or call Dawn House customer service: 1-888-DAWNHSE (1-888-329-6473)



# THE PUCK VOICE ACTIVATED SYSTEM OVERVIEW

PLEASE FAMILIARIZE YOURSELF WITH ALL SAFETY INFORMATION BEFORE SETTING UP THE PUCK VOICE ACTIVATED SYSTEM.

**ATTENTION:** Your adjustable base can pose an entrapment hazard which is increased in households with small children and or pets. Using voice controls further increases this entrapment hazard due to the potential of unintentionally triggering a command vocally. The voice controls could be unintentionally triggered by yourself, a small child, the television, a radio program, etc. and by using this product you agree that you have read and reviewed the commands, including the Emergency Commands, and acknowledge the increased entrapment risk associated with using voice commands.

If you agree with this statement, please read the instructions on the following pages to learn how to setup the Puck, however if you have any questions in regard to the use of voice controls please contact customer service prior to activating the Puck.

## OVERVIEW

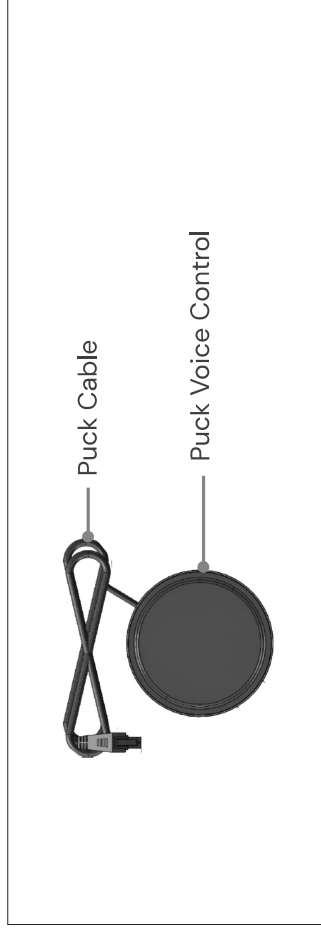

## SAFETY INFORMATION

If you wish to stop using voice commands, you can turn the device off by switching the slider on the puck to the middle "OFF" position. Your adjustable base can pose an entrapment hazard and there is an increased risk for households with small children and or pets. Using voice controls increases this entrapment hazard due to the potential of accidentally triggering a command vocally. The voice controls could be unintentionally triggered by a small child, television, radio program, etc., please read the "Emergency Commands" section so that you are familiar with these commands in the event of an emergency.

**ENTRAPMENT HAZARD:** This bed can crush and kill when it moves. Using voice controls may increase this risk. Review emergency commands before activating voice controls.

## WIRELESS CHARGER

- **Intro:** This item has a wireless charging function. The maximum charging power is 10W. Place the device to be charged in the center of the wireless charger. During normal operation, the green light will indicate that it is charging.
- **Overheat Protection:** In a high temperature environment, when the internal temperature of the product rises to 158 degrees (F), the wireless charger will enter a protection mode and the product will turn off the wireless charging function. When the internal temperature lowers to below 122 degrees (F), the charging function will resume.
- **Incompatible Device Detection:** If an incompatible device is placed on the charger, the red light will indicate that the device should be removed.

# THE PUCK VOICE ACTIVATED SYSTEM INSTALLATION

FOLLOW THE INSTALLATION STEPS BELOW TO SET UP THE PUCK VOICE ACTIVATED SYSTEM.

## STEP 1

Please take a minute to familiarize yourself with the voice commands listed on the page 17.

## STEP 2

Remove the Puck from the box.

## STEP 3

Locate the Puck connector and connect it with the plug as shown in the picture.

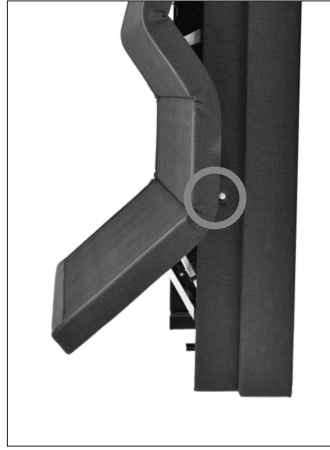

## STEP 4

The Puck Voice Control will arrive in the Off position and you will need to activate the Puck by selecting an invocation command of your preference.

Use the slider switch on the back side of the Puck to select the invocation phrase you wish to use, either "HELLO DAWN" or "HELLO BED".

Note: If you have a split base, each side must have a different invocation phrase in order to work independently.



## WAKE UP DEVICE

To use the Puck Voice Activated System, simply say the invocation command you chose during setup, either "HELLO DAWN" or "HELLO BED", and wait 1-2 seconds for the microphone to activate. Once the microphone is activated, indicated by the blue light, it will be active for 8 seconds. While the microphone is active you can now use any of the voice commands listed below to control your adjustable base. If no command is heard within 8 seconds, the Puck will enter "sleep mode" and the microphone will be deactivated.

Proceed to the next page for list of voice commands.

# THE PUCK VOICE COMMANDS

ONCE THE INVOCATION PHRASE HAS BEEN UTTERED, THE MICROPHONE WILL BE ACTIVE FOR 8 SECONDS WHICH IS INDICATED BY THE BLUE LIGHT. WHILE THE MICROPHONE IS ACTIVE YOU CAN NOW USE ANY OF THE COMMAND PHRASES LISTED BELOW TO CONTROL YOUR ADJUSTABLE BASE.

	VOICE COMMAND	EXPLANATION
Common Controls	GOOD-NIGHT	Flat bed
	RISE-AND-SHINE	Adjust the bed to preset position for Zero-G®
	RAISE-HEAD	Head up 3s
Actuator Controls	LOWER-HEAD	Head down 3s
	RAISE-FOOT	Foot up 3s
	LOWER-FOOT	Foot down 3s
	LIFT-BASE	Bed height rises 3s
	LOWER-BASE	Bed height lowers 3s
	FLAT-PRESET	Flat bed
Presets	ZERO-G®/ZERO-GRAVITY	Adjust the bed to preset position for Zero-G®
	SIT-UP	Adjust the bed to preset position for READ
	GETTING-IN	Adjust the bed to preset position for IN
	GETTING-OUT	Adjust the bed to preset position for OUT
Underbed Lights	TURN-ON-LIGHT	Turn on the bed lights
	TURN-OFF-LIGHT	Turn off the bed lights
Message	TURN-ON-MESSAGE	Turn on the bed message
	TURN-OFF-MESSAGE	Turn off the bed message
	MESSAGE-UP	Increase message intensity
	MESSAGE-DOWN	Reduce message intensity

	VOICE COMMAND	EXPLANATION
 EMERGENCY COMMANDS	STOP	Stop all movement
	ALL-UP	Raise both the head & Foot 6 seconds

# SYNCING TWO TWIN LONG BASES (OPTIONAL)

A SYNC CORD IS INCLUDED WITH THE BASE. NOT AVAILABLE ON QUEEN OR FULL SIZE BASES. THE SYNC CORD CONNECTS THE TWO CONTROL BOXES TO SYNCHRONIZE THE MOVEMENT OF THE TWO BASES. USE THIS FOR A KING SIZE MATTRESS ON TWO ADJACENT TWIN LONG BASES.

## STEP 1

Unplug both bases from the power source.

## STEP 2

Connect the Sync Cord to the same plug as the Puck Voice Control but on the opposite side. It is located near the motion detector.

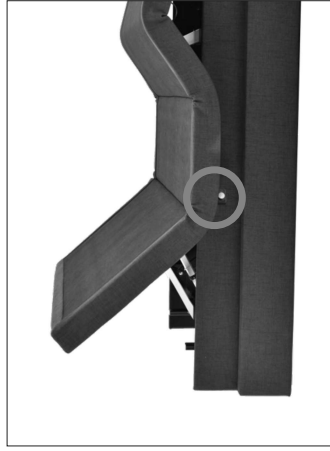

## STEP 3

Plug bases back into the power source. Ensure that all cords are securely attached.

The system is now linked. Pressing buttons on either remote will control both bases simultaneously.

## PERFORMANCE NOTES

- If bases become mismatched, returning the bases to the flat or lowest position will re-sync the mechanical position.
- (Fig 1) The motion detector switch on both remotes needs to be in the same position for normal operation.

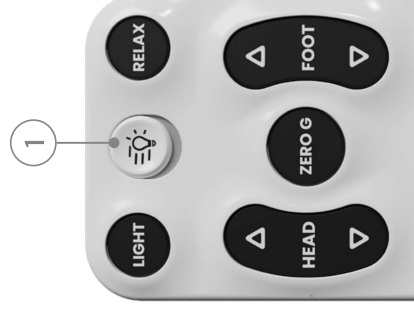

# EMERGENCY BATTERY BACKUP STRAP

**FOR EMERGENCY USE ONLY, IN CASE OF A POWER OUTAGE. BATTERIES ARE NOT TO BE USED FOR NORMAL OPERATION OF THE BED.**

## STEP 1

Manually lift the head section to access the power supply. Disconnect the Power Supply from the input cord that is connected to the control box.

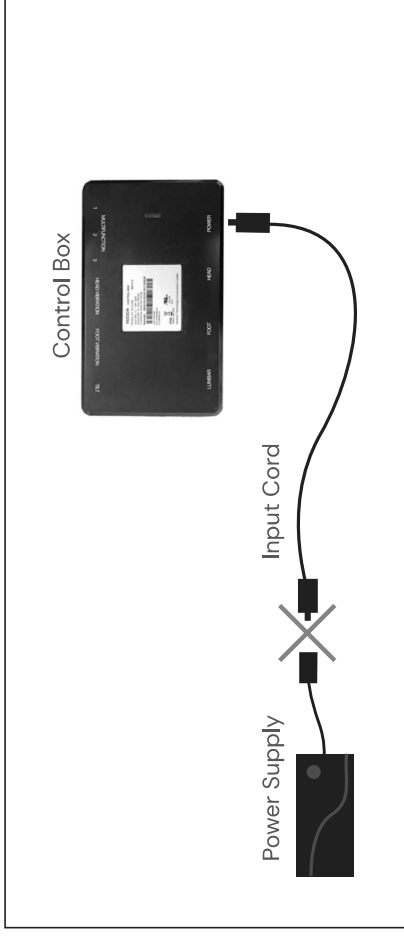

## STEP 3

Connect the end of the Battery Backup Strap to the input cord and then use the remote to return the base to a flat position.

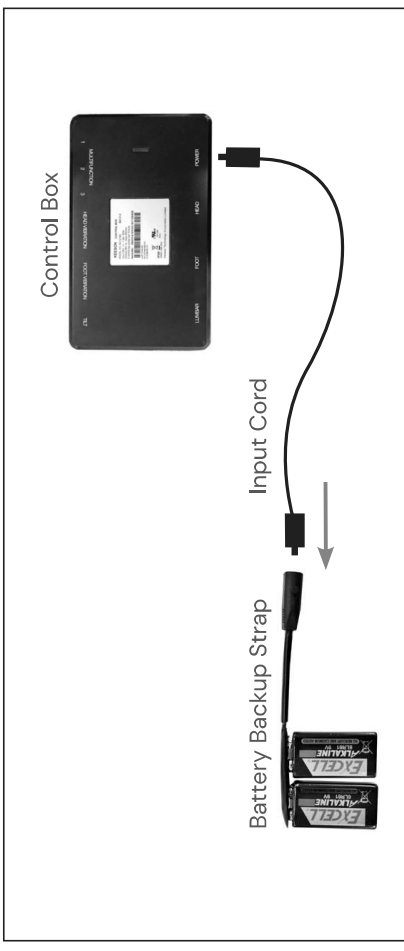

## STEP 2

Connect the Battery Backup Strap to the (2) Alkaline 9 Volt Batteries. Do not mix brand name Batteries.



**Note:** Detach the Battery Backup Strap and reconnect the power supply after the emergency is over, as the system will continue to draw power from the batteries even if not in use.