

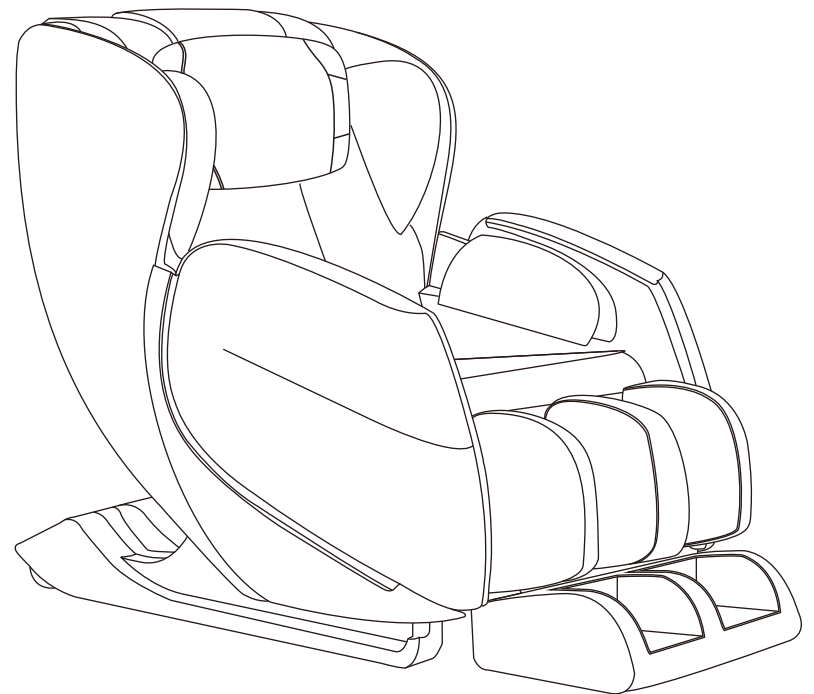

E330 Kofuko Massage Chair

User's Manual



Kyoto Massage Chairs
800-242-0761 | www.kyotamassagechairs.com

www.kyotamassagechairs.com

Congratulations and thank you for trusting Kyota Massage Chairs. Combined with healthy eating, exercise, and a good sleep regimen, your massage chair is a great way to take care of your body and mind. This will lead to a happy, productive lifestyle.

Please read and follow all safety and operating instructions listed in this user manual prior to use. Basic precautions should always be used when operating an electrical appliance.

Contact Kyota Massage Chairs' Technical Support Team with any questions or concerns at 800-242-0761. Our dedicated specialists will be happy to assist you!

Please Note: We reserve the right to make changes to information published in this manual, including but not limited to, specifications and product descriptions. These changes may be made at any time and without notice. This manual supersedes and replaces all information supplied prior to the publication hereof.

Specifications

Model	E330 Kofuko Massage Chair
Dimension of Main Body (in)	59 x 32 x 35 (L x W X H)
Necessary Clearance to Wall (in)	2
Net Weight (lbs)	187.4
Shipping Weight (lbs)	233.7
Max. User Weight (lbs)	308
Voltage	110V~ 60Hz
Fuse	3.15 AMP
Power Consumption	230W
Safety Standards	Type 1

Table of Contents

Preparation	Safety Precautions	2
	Massage Chair Parts	6

Usage & Maintenance	Installation & Placement Instructions	7
	Before & After Using the Chair	9
	Remote & Massage Chair Operation	10
	Product Care & Storage	14

Additional Info.	Troubleshooting	15
	Specifications	16

Watch the Assembly Video:
<https://kyotamassagechairs.com/assembly-tutorials/E330>

IMPORTANT SAFETY INSTRUCTIONS

CAUTION

- TO REDUCE THE RISK OF ELECTRIC SHOCK, DO NOT REMOVE COVER. THERE ARE NO SERVICEABLE PARTS INSIDE.
- TO REDUCE RISK OF FIRE OR ELECTRIC SHOCK, DO NOT EXPOSE THE MASSAGE CHAIR TO RAIN OR MOISTURE.



This symbol indicates the presence of uninsulated “dangerous voltage” within the massage chair’s enclosure that may be of sufficient magnitude to constitute a risk of electric shock.



This symbol indicates the presence of important operating and maintenance instructions in the literature accompanying the massage chair.

This massage chair is intended for household use only.

When using an electrical appliance, basic precautions should always be followed.

Read all instructions before using this massage chair.

⚠ DANGER - To reduce the risk of electric shock:

1. Always unplug this massage chair from the electrical outlet immediately after using and before cleaning.
2. If liquid is accidentally spilled onto the chair, remove the power plug from the electrical outlet immediately. Do not use wet hands to connect or disconnect the power plug from the electrical outlet.
3. Do not operate during a lightning storm.
4. Although operation will be stopped automatically by the Auto Timer function, always remember to turn off the main power switch after use.
5. Do not place the power cord under the chair or under any other heavy objects.
6. Do not wind the power cord around the chair as this may damage the cord and result in a fire or electric shock.
7. Do not operate the chair with a damaged cord or with an extension cord.
8. Do not use the chair if the electrical outlet is loose.

If you encounter problems while operating your Kyota E330 Kofuko massage chair, try the suggestions below. If the issue(s) persist, flip the main power switch on the back of the chair to the Off position and remove the power plug from the outlet. Contact Infinity’s technical support team at 800-242-0761 for service.

Do not disassemble or attempt to repair the massage chair yourself. Doing so will void the warranty and Kyota will not bear any responsibility for any subsequent consequences.

Problem	Possible Cause/Solution
The massage chair is connected to a power source, but is not functioning.	<ul style="list-style-type: none"> • Check that the main power switch on the back of the chair is in the On position. • Check that the power plug is inserted properly and the power outlet is functioning properly. • Press the Power button on the remote. • Check the fuse next to the main switch in the back of the chair.
Sounds are coming from the massage mechanism.	It is normal for the motors to make noise while operating or rubbing against the backrest area.
Backrest or legrest will not extend or retract.	There may be too much pressure placed on the backrest or legrest. Reduce the weight or pressure on the backrest or legrest.
The seat or legrest airbag is not working.	Check to see if there is an air tube blockage or if an air tube is pinched. If so, clear the air tube or straighten it out.

Storing the Massage Chair

- Disconnect the massage chair from the power source after use.
- Do not expose the massage chair to direct sunlight, high temperature, or high humidity. This could cause fading or other damage to the upholstery.
- Do not put heavy objects on the massage chair.
- If the outer cover is torn or the mechanism is damaged, stop using the chair and contact Infinity for assistance.

Cleaning the Massage Chair

Follow the steps below to clean your massage chair:

- Remove the main plug from the outlet.
- Clean the synthetic leather, controller, cords with a dry cloth.
- If necessary, you can dampen a soft cloth with a neutral cleaning solution or water to clean the synthetic leather. Lysol wipes are another safe and easy way to clean this material. Then, wipe it with a dry cloth and let air dry.
- Any cloth material of the chair (e.g., the inside of the arm airbags or calf airbags) can be spot cleaned with a soft cloth dampened with a weak neutral detergent and gently clean where necessary. Avoid cleaning the fabric too often so as to avoid wear and tear.
- To clean any plastic parts of the chair (e.g., the base), use a soft cloth lightly soaked in a neutral detergent. Then, wipe again with a water-dampened cloth. Finally, wipe it with a clean, dry cloth.

Caution

- Do not immerse the chair in water.
- Never use scouring pads, abrasive cleaning agents (e.g., benzene or thinner), or harsh chemicals such as petroleum or acetone to clean the chair. Additionally, never use heat to dry the chair after cleaning. These items may cause fading or other damage to the upholstery.
- Any additional servicing should be performed by an authorized service representative. This chair has no user serviceable parts inside.

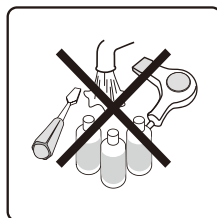

WARNING - To reduce the risk of burns, fire, electric shock, or injury:

1. This massage chair should never be left unattended when plugged in. Unplug from outlet when not in use, and before putting on or taking off parts.
2. Do not operate under blanket or pillow. Excessive heating can occur and cause fire, electric shock, or other injury.
3. Close supervision is necessary when this chair is used by or near children, pets, or disabled individuals. Keep children and pets away from extended foot support.
4. Use this massage chair only for its intended use as described in this manual. Do not use attachments not recommended by Infinity.
5. Never operate this massage chair if it has a damaged cord or plug, if it is not working properly, if it has been dropped or damaged, or if it has been damaged by water. Contact Kyota's technical support team at 800-242-0761 for assistance.
6. Do not move or carry this massage chair by the power cord, or use the cord as a handle.
7. Keep the cord away from heated surfaces.
8. Never operate the massage chair with the air openings blocked. Keep the air openings free of lint, hair, and other debris.
9. Never drop or insert any object into any opening.
10. Do not use outdoors.
11. Do not operate where aerosol (spray) products are being used, or where oxygen is being administered.
12. To disconnect, turn all controls to the OFF position, then remove the plug from the outlet.
13. Use heated surfaces carefully. May cause serious burns. Do not use over sensitive areas or on areas with poor circulation. The unattended use of heat by children or disabled individuals may be dangerous.
14. Never use pins or other metallic fasteners with this chair.
15. Never remove the cover from this chair. Do not use the chair when the upholstery is ripped, torn, or removed. This may cause injury or malfunction. Carefully examine the covering before each use. Call Kyota's technical support team if the covering shows any sign of deterioration, such as blistering, peeling, cracking, or ripping.
16. Keep dry. Do not operate the massage chair in a wet or moist environment. Do not use the chair when your body is wet, or operate with wet hands.
17. Do not use the massage chair while wearing excessively loose clothing or jewelry.
18. Keep long hair away from massage chair openings and moving parts during use.
19. Do not insert your hand or foot along the path of the massage rollers during use.
20. Any individual who is pregnant; uses a pacemaker; suffers from diabetes, phlebitis, and/or thrombosis; is at an increased risk of developing blood clots due to recent surgery; or is being treated or has been diagnosed with any other medical condition or physical injury should consult a physician before using this massage chair.
21. This massage chair is designed as a non-professional solution to help soothe tired, aching muscles. It is not intended for self-treatment of conditions that should be managed by a qualified healthcare provider. If your ailments and symptoms persist or worsen after use, contact your doctor immediately.

22. Do not use this chair if you are not feeling well.
23. Stop operation immediately if you experience any discomfort.
24. Do not fall asleep during the massage session.
25. Do not operate after consuming pain killers, sedatives, or alcohol.
26. Do not use this chair in combination with other therapeutic equipment or items such as an electric blanket, as this may result in ineffectiveness or injury.
27. Do not stand on or in this massage chair. Use only while seated.
28. Do not disassemble any part of the chair. Touching the internal components may result in malfunction or electric shock. Instead, contact Infinity's technical support team immediately for professional assistance.
29. Always position the massage chair on a flat, level surface.
30. Do not operate for more than 30 consecutive minutes. Turn off the chair and allow it to rest for 30 minutes before using again. This will prolong the life of the chair.
31. Do not perform continuous massage on the same spot of your body for more than 5 minutes at a time, as this may result in excessive stimulation and may have adverse effects.
32. Never use the chair on open skin wounds or swollen, inflamed areas.
33. Do not apply massage rollers directly on the head, elbow or knee joints, torso, or abdomen.
34. If the power goes off during use, be sure to turn the power switch to the OFF position and pull the power plug out from the outlet to prevent damage from occurring when the power is restored.

SAVE THESE INSTRUCTIONS

Grounding Instructions

This product must be grounded. If it should malfunction or break down, grounding provides a path of least resistance for the electric current to reduce the risk of electric shock.

This product is equipped with a cord with an equipment-grounding conductor and a grounding plug. The plug must be plugged into an appropriate outlet that is properly installed and grounded in accordance with all local codes and ordinances.

DANGER: Improper connection of the equipment-grounding conductor can result in a risk of electric shock.

Check with a qualified electrician or serviceperson if you are in doubt as to whether the product is properly grounded. Do not modify the plug provided with the product. If it does not fit the outlet, have a proper outlet installed by a qualified electrician.

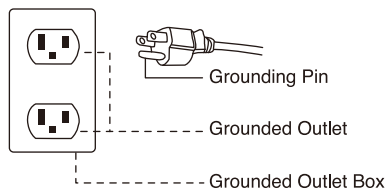

Back Up/Down

Press this button up or down to recline or raise the massage chair backrest.



Foot Up/Down

Press this button up or down to lift or lower the massage chair legrest.



Massage Rollers Up/Down

Press this button up or down to adjust the position of the massage roller mechanism.



Air Massage Zone

Press this button select airbag regions. Choose from foot & calf; arms; shoulders; foot, calf & arms; full (foot, calf, arms, & shoulders); or none.



Air Massage Strength

Press this button to adjust the air massage strength. Choose from three intensity levels.



+5 Minute Timer

Press this button to increase the massage session time in 5-minute increments.

Starting Your Massage

Body Scanning

The massage chair will perform a scan every time a new user sits in it and selects an Auto or Manual program. This scanning technology ensures an accurate and personalized massage for every individual.



Quick Massage Program

Press for a quick demonstration of all available massage techniques.



Zero Gravity

Press once to place the chair in zero gravity position 1.
 Press twice to place the chair in zero gravity position 2.
 Press three times to place the chair in zero gravity position 3.
 Press four times to return the chair to its original upright position.



Lumbar Heat

Press to turn on lumbar heat. Press again to turn off.



Pause Massage

Press this button to force stop the chair during a program. This will stop all functions immediately. Press again to resume functions.



Manual Massage

Press to toggle between manual massage techniques. Indicator lights are cumulative: Technique 1=1 light, Technique 2=2 lights, etc.



Tapping/Kneading Speed

Press this button to adjust the tapping/kneading massage speed. Choose from three speeds.



Roller Width

Press this button to adjust the massage roller width. Choose from three width levels.



Back Zone

Press this button to select the massage roller zone. Choose from full coverage, upper back, lower back, or targeted (point) massage.



Tapping/Kneading Speed

Press this button to turn the foot rollers on or off.

FCC Statement

1. This device complies with Part 15 of the FCC Rules. Operation is subject to the following two conditions:
 - (1) This device may not cause harmful interference, and
 - (2) This device must accept any interference received, including interference that may cause undesired operation.
2. Changes or modifications not expressly approved by the party responsible for compliance could void the user's authority to operate the equipment.

This equipment has been tested and found to comply with the limits for a Class B digital device, pursuant to part 15 of the FCC Rules.

These limits are designed to provide reasonable protection against harmful interference in a residential installation. This equipment generates, uses and can radiate radio frequency energy and, if not installed and used in accordance with the instructions, may cause harmful interference to radio communications. However, there is no guarantee that interference will not occur in a particular installation.

If this equipment does cause harmful interference to radio or television reception, which can be determined by turning the equipment off and on, the user is encouraged to try to correct the interference by one or more of the following measures:

- Reorient or relocate the receiving antenna.
- Increase the separation between the equipment and receiver.
- Connect the equipment into an outlet on a circuit different from that to which the receiver is connected.
- Consult the dealer or an experienced radio/TV technician for help.

FCC Radiation Exposure Statement:

This equipment complies with FCC radiation exposure limits set forth for an uncontrolled environment. In order to avoid the possibility of exceeding the FCC radio frequency exposure limits, human proximity to the antenna shall not be less than 20cm (8 inches) during normal operation.

Massage Chair Parts

Front of Chair

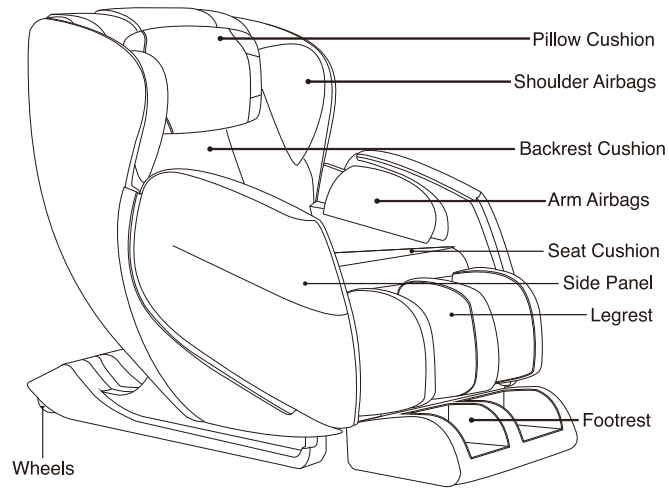

Back of Chair

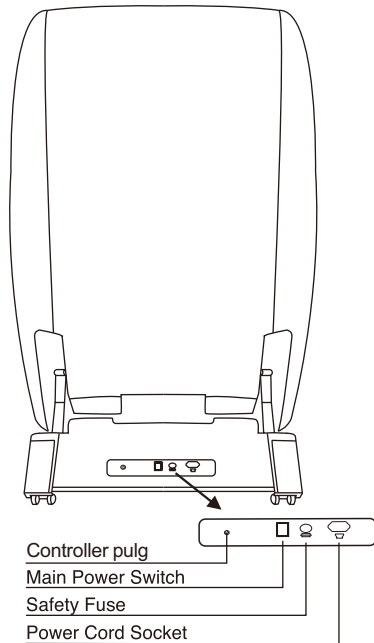

Remote & Massage Chair Operation

Remote Display Diagram

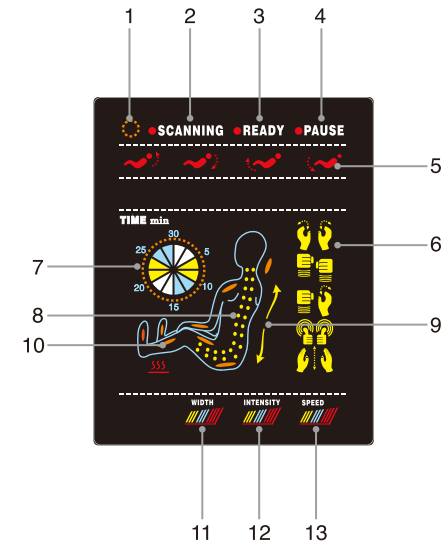

1. Massage chair is powered on.
2. Massage chair is scanning your back contour and preparing for initiation.
3. Scanning is complete and chair is ready to begin massage programs.
4. Pause button has been pressed and chair is temporarily stopped.
5. Recline position adjustment buttons.
6. Displays which massage technique is currently active.
7. Displays time remaining in current massage program.
8. Depicts roller position.
9. Depicts the direction of the massage rollers (upwards or downwards).
10. Shows active airbag region(s).
11. Shows roller width level.
12. Shows airbag intensity level.
13. Shows tapping/kneading speed level.

Remote Diagram



Watch the Assembly Video:

<https://kyotamassagechairs.com/assembly-tutorials/E330>

Unpacking the Massage Chair

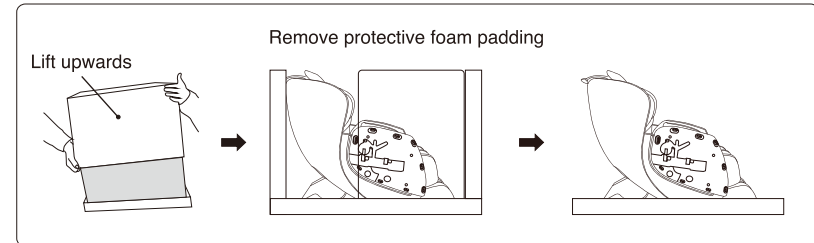

1. Remove the carton as shown above.
2. Take out the foam.
3. Unpack the spare parts. These should include the remote, power cord, and user manual.

Install the Side Panels

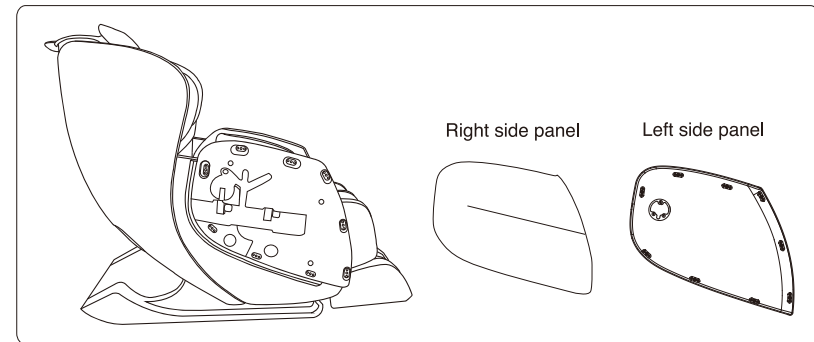

Take the right side panel and align it with the connectors on the right side of the chair, then snap on. Repeat with left side panel.

Moving the Massage Chair

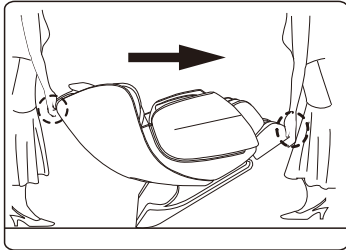

- As illustrated, push the backrest downwards and tilt the chair onto its wheels at a 45° angle. Slowly push and maneuver the massage chair to the desired location. Lower the chair slowly until it is fully flat on the floor.

Caution:

- Do not move the massage chair when occupied or in use.
- Moving the massage chair may damage floors. We recommend moving the chair on

- rugs or carpeted floors.
- Do not drop or suddenly let go of the chair when moving it, as this may damage the chair or the floor.
- We advise two people move the massage chair together.

Chair Placement

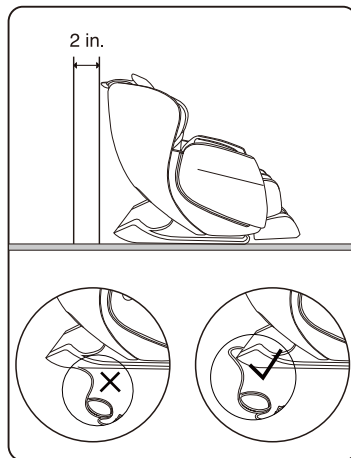

- When placing your massage chair, be sure to leave at least 2 in. of space between the back of the chair and any wall or other objects to allow it to recline safely.
- When using the massage chair, ensure there are no people, pets, or objects within 20 in. of the chair to allow the footrest to extend safely.

Caution:

- In order to avoid damage or injury, do not place the massage chair on a wet or uneven floor.

Preparing the Massage Chair

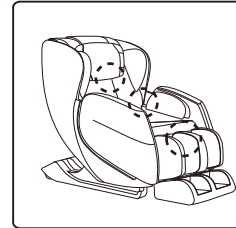

1. Make sure that the chair is assembled correctly and ready for use by doing the following:
 - Ensure the headrest and backrest pads are properly attached and sitting smoothly on the chair.
 - Confirm the power plug is properly connected and in good working condition.
 - Make sure the legrest is down in its original position before sitting in the chair in order to avoid damage.

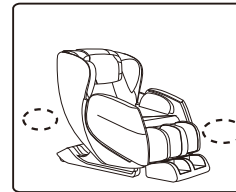

2. Check the surrounding environment.
 - Make sure there are no objects, pets, or small children around the massage chair before using it.

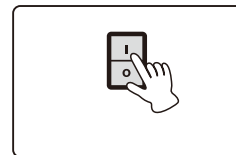

3. Connect the chair to power:
 - Connect the power cord to the chair.
 - Turn on the power switch on the power box, located on the rear of the chair.

Turning Off the Massage Chair

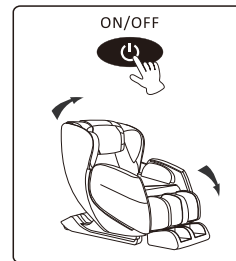

1. After the massage program is completed, press the Power button on the massage chair to turn it off. The chair will reset to its original upright position.
 - Ensure the surrounding area is clear of any pets, children, or objects prior to turning off and resetting the chair.
 - Keep your arms and legs away from gaps between the armrest, legrest, and footrest to prevent any pinching or injury.

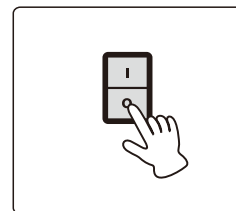

2. Turn off the main power switch.
3. Unplug the power cord from the outlet.
 - Do not pull on the cord to unplug from the wall.
 - Do not handle the power cord with wet hands.