



Protekt® Aire 9900

True Low Air Loss with Alternating Pressure & Pulsation

User Manual



Proactive Medical Products
270 Washington Street
Mount Vernon, NY 10553
Phone# 1-855-BE-PROACTIVE (855-237-7622)
Fax# 845-205-6005
www.proactivemedical.com

IMPORTANT SAFEGUARDS

READ ALL INSTRUCTIONS BEFORE OPERATING THIS DEVICE



NOTE, CAUTION AND WARNING STATEMENTS:

NOTE – Indicate some tips.

CAUTION – Indicate correct operating or maintenance procedures in order to prevent damage to or destruction of the equipment or other property.

WARNING – Call attention to a potential danger that requires correct procedures or practices in order to prevent personal injury.



WARNING– To reduce the risk of electrocution:

1. Patients are not allowed to operate the product. Always unplug this product immediately while it's not in use.
2. Do not disassemble the Pump to avoid electrocution.
3. Do not place or store product where it can fall or be pulled into a tub or sink.
4. Do not place in or drop into water or other liquid. Do not use while bathing.
5. Do not reach for a product that has fallen into water. Unplug immediately.











WARNING–To reduce the risk of burns, electrocution, fire or injury to person:

1. The system must be operated with the mattress connected to the pump. Please do not power-off or unplug the Pump while in use.
2. Always use the same voltage as outlet label. Do not use the other power cords on the pump. Keep the plastic packing away from children and pets to prevent suffocation hazards.
3. Equipment is not suitable to use in the presence of a flammable anesthetic mixture with air, with oxygen or nitrous oxide.
4. Keep away from sharp objects.
5. Close supervision is necessary when this product is used by, on, or near children or people with disabilities.
6. Use this product only for its intended use as described in this manual. Do not use attachments not recommended by the manufacturer.
7. Never operate this product if it has a damaged cord or plug, if it is not working properly, if it has been dropped or damaged, or dropped into water. Return the product to a service center or to the distributor for examination and repair.
8. Keep the power cord away from heated surfaces.
9. Never block the air openings of this product or place it on a soft surface, such as a bed or couch, where the openings may be blocked. Keep the air opening free of lint, hair, and other similar particles.

11. Connect this product to a properly grounded outlet only. See Grounding Instruction.
12. Avoid dropping or putting any heavy object on the pump.
13. Put power cord or hose tube at patient's foot area to avoid winding around patient's neck.
14. To avoid electromagnetic interference, the patient environment should not have strong electro-magnetic or RF generated equipment nearby.
15. The PUMP will have minor heat generated in operation, please do not directly contact the surface continuously for more than 1 minute.
16. Avoid the risk of electrocution by grounding the ground pin with grounding power outlet.
17. When the main supply is lost or has temporarily failed, the pump will stop and the power failure alarm will alarm up to 20 minutes. This is normal and the product will return to normal operation once the main supply is resumed.
18. The connection of lift-up detection to the PUMP shall be performed by the operator. It's not designed for patient to do the connection.

Product Symbol Description

SYMBOLS	DESCRIPTION
I	POWER ON
O	POWER OFF
	ATTENTION
	“BF” SYMBOL, INDICATE THIS PRODUCT IS ACCORDING TO THE DEGREE OF PROTECTION AGAINST ELECTRIC SHOCK FOR TYPE BF EQUIPMENT, APPLIED PART:MATTRESS
	CAUTION, READ THE INSTRUTION BEFORE USE
	AWAY FROM THE FLAME
IP21	WATER AND DUST PROTECTION CLASSIFICAITON
	FUSE SPECIFICATION
	DISPOSAL OF ELECTRICAL & ELECTRONIC EQUIPMENT (WEEE): THIS PRODUCT SHOULD BE HANDED OVER TO AN APPLICABLE COLLECTION POINT FOR THE RECYCLING OF ELECTRICAL AND ELECTRONIC EQUIPMENT.
	UL CERTIFICATION LOGO (COMPLIACE WITH IEC60601-1) WITH RESPECT TO ELECTRICAL SHOCK, FIRE AND MECHANICAL HAZARDS ONLY IN ACCORDANCE WITH IEC60601-1.
	CB CERTIFICATION LOGO
	CE CERTIFICATION LOGO

Contents

1.	INTRODUCTION	6
2.	INTENDED USE	6
3.	PRODUCT DESCRIPTION	6
4.	PRODUCT INSTALLATION GUIDE	7
5.	PANEL DISPLAY AND OPERATION GUIDE	10
6.	CLEANING	17
7.	STORAGE	18
8.	MAINTENANCE	18
9.	THE DISPOSAL OF AIR MATTRESS	19
10.	TROUBLESHOOTING	20
11.	TECHNICAL DATA.....	21

1. INTRODUCTION

This manual provides the information required for the initial set up and operation of the **Proactive Medical Product's Protekt® Aire 9900 Mattress System**. Before operating the **Protekt® Aire 9900 Mattress System**, be sure to read and understand in detail the contents of this manual.

2. INTENDED USE

The **Protekt® Aire 9900 Mattress System** is intended to help and reduce the incidence of pressure ulcers while optimizing patient's comfort. The **Protekt® Aire 9900 Mattress System** may be used in a variety of settings including, but not limited to individual home care setting and long-term care patients suffering from pressure ulcers, or pain management as prescribed by physician.



NOTE: Equipment is not suitable for use in the presence of a flammable anesthetic mixture with air or with oxygen or nitrous oxide.

3. PRODUCT DESCRIPTION

The **Protekt® Aire 9900 Mattress System** is an alternating mattress replacement system used in the prevention and relief for patients with, or vulnerable to, pressure ulcers. The **Protekt® Aire 9900 Mattress System** offers patients a comfortable and relaxing support surface by using the established principles of alternating therapy, pulsation and true low air loss which can both prevent skin breakdown and enhance healing.

The Control Unit of the **Protekt® Aire 9900 Mattress System** is a Pump featuring a digital pressure adjustment function, mode selections, and audiovisual alarms. The 18 air cells mattress unit provides a unique design which keeps the lower sections of air cells constantly inflated while alternating and deflating the upper sections. The 3 static head cells remain static and provide a "pillow" support for optimum comfort. The mattress has a heavy-duty polyester base sheet with a vapor permeable nylon-PU coated with quilted cover sheet.

In the event of cardiac arrest, rapid deflation is achieved by using the highly visible CPR release valve.

4. PRODUCT INSTALLATION GUIDE

1. Unpack the box to inspect all items for any damage that may have occurred during shipping. If there is any damage, please contact your dealer immediately for assistance.
2. Place the mattress on top of the bed frame. The feet symbol on both side of the mattress indicates location of the foot end.

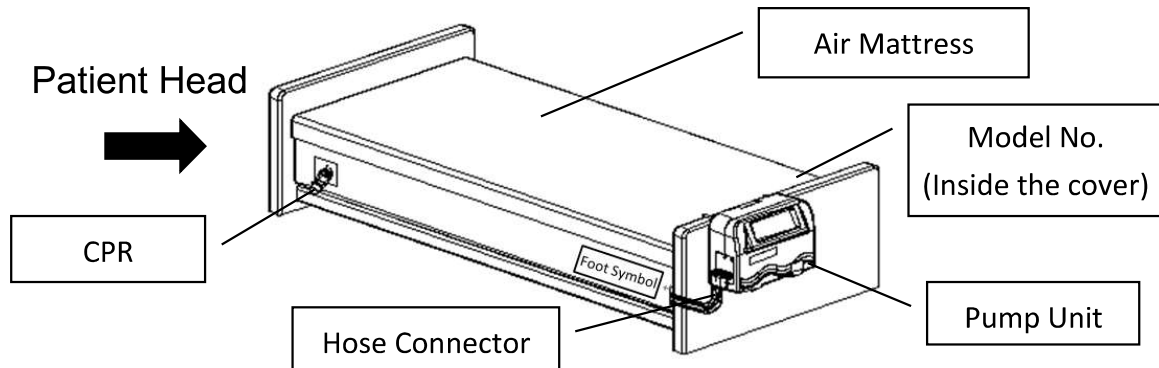

3. Secure the mattress onto the bed frame by using the elastic straps or binding side straps.

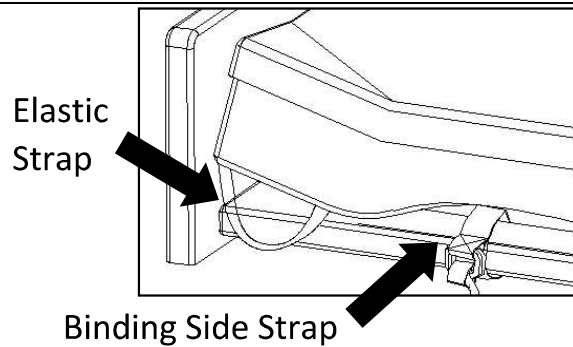

4. Ensure the CPR valve is at CLOSE position before turning on the power.

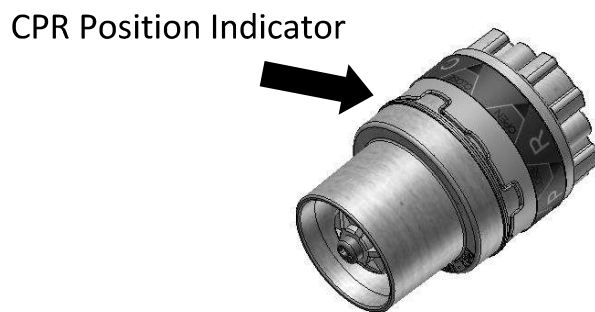

5. Position the Pump by its elastic hanger brackets over footboard of the bed. The elastic hanger brackets will self-adjust onto the footboard tightly.
6. Remove the Transport Cap of the hose connector and connect the hose connector to the Pump unit. Firmly push the hose connector into position and a "click" sound will secure the connection.

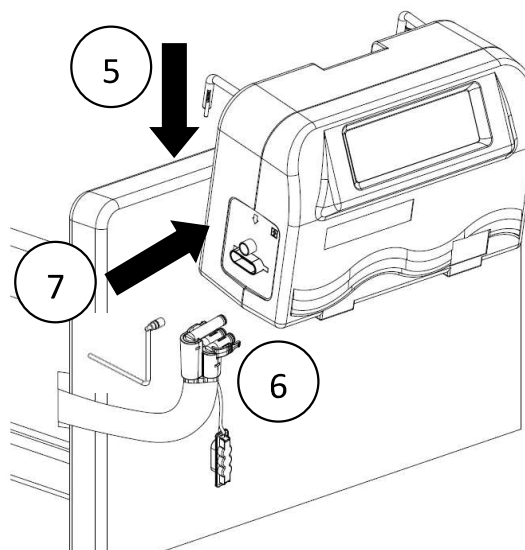

7. Connect the Lift-Up Detection cable to the Pump unit by first align and push-in the 3 pins connector then gently turn the screw clockwise to secure the connection.

Follow the direction for connection.

Lift-Up Detection

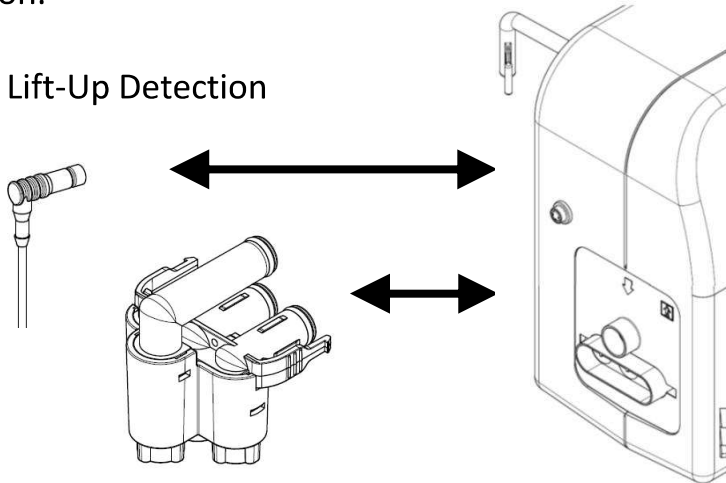

8. Connect the power cord to the Pump. The power switch should remain off.
9. Press the red power cord protector downward to secure the power cord.
10. Plug the power cord into the electrical outlet.

- ⚠ NOTE: Check and ensure the Pump unit is suitable for the local power voltage.
- ⚠ CAUTION: The Pump can only be applied to the mattress recommended by the manufacturer. Do not use the Pump for any other purpose.
- ⚠ WARNING: Do not place the Pump unit in area where power cord can come off easily.

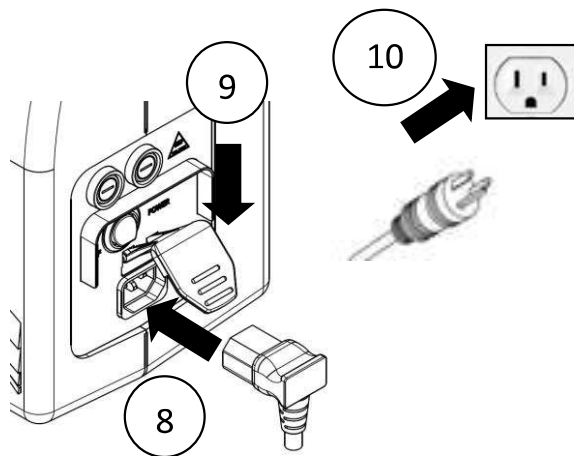

11. For patient's transportation, press "Auto Firm" button and wait for 5 minutes for the mattress to be inflated. Disconnect the hose from the Pump unit and put on the hose connector Transport Cap to keep the mattress inflated.

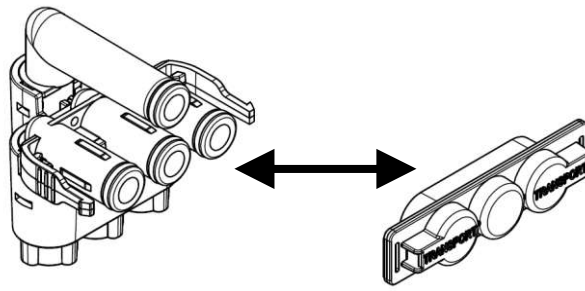

Bi-directional Transport Cap

5. PANEL DISPLAY AND OPERATION GUIDE

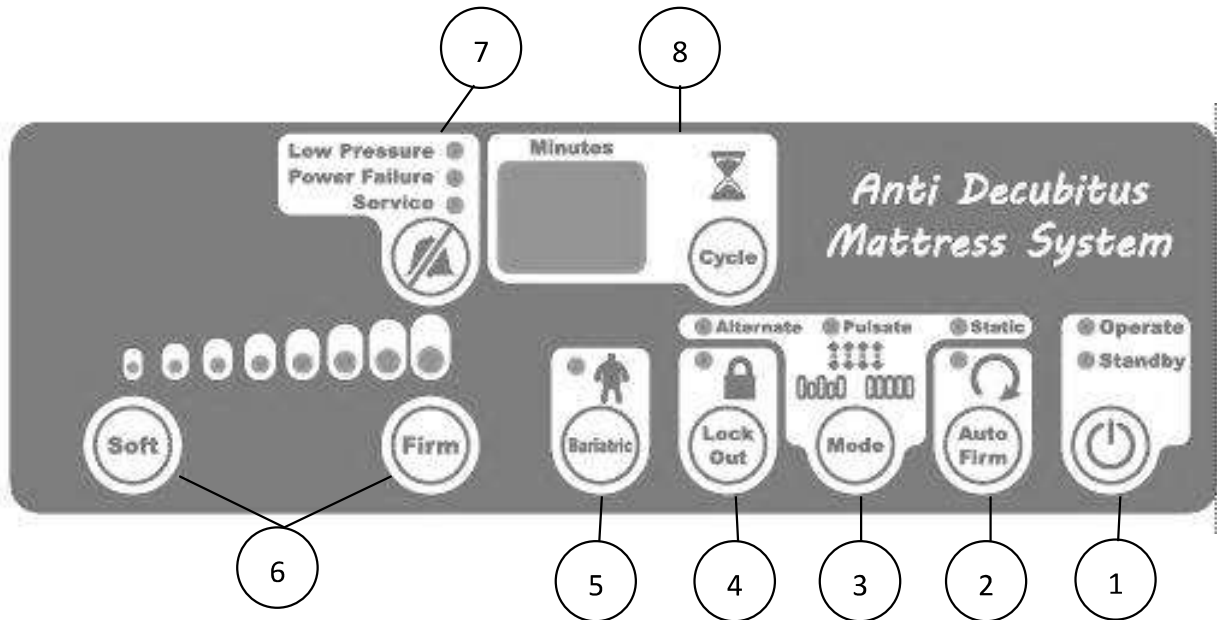

5.1 PANEL DISPLAY

- ① Operate or Standby
- ② Auto Firm
- ③ Function Mode Selection (Alternate/Pulsate/Static)
- ④ Panel Lock-Out
- ⑤ Bariatric Switch Button
- ⑥ Comfort Control (Soft and Firm)
- ⑦ Alarm Mute and Alarm Indicator
 - Low Pressure Alarm Indicator
 - Power Failure Alarm Indicator
 - Service (Malfunction) Alarm Indicator
- ⑧ Alternate/Pulsate Cycle Time or Warning Code Display

5.1.1 Operate or Standby



Press this button to start operating or go into standby.

5.1.2 Auto-Firm



The Pump will go into the inflation mode (LED lights flashing) every time the operate mode is triggered. This insures the mattress to be able to reach its maximum operating pressure. Once the max pressure level is reached, the pump will automatically switch into the previous selected mode and comfort level. The user can also use this function as full mattress inflation during patient sit-up or ingress/egress for better support.

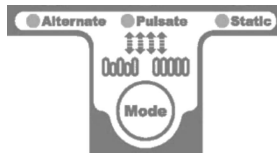

5.1.3 Function Mode Switch

- Alternato – the air cells of the mattress will be proportionally deflated to reduce the surface pressure. The alternating cycle will continue at the selected cycle time until another mode is selected.
- Pulsate –the mattress maintains at the selected pressure in static mode and changes from 100% to 70% of the selected pressure according to the selected Pulsate cycle time. The Pulsate cycle will continue until another mode is selected.
- Static – the mattress maintains at 70% of the selected pressure in alternate mode.



5.1.4 Panel Lock-Out

Press the Lock-Out button to lock the panel. Should the panel remain untouched for 30 seconds, the Lock-Out feature will lock the panel to prevent accident from changing setting without notice. To unlock, press the Lock-Out button for 3 seconds.



5.1.5 Bariatric

This feature enhances the output of the Pump for heavier patient support. Refer to **Table 1 Weight and Comfort Level Reference** for weight and comfort level recommendation.



5.1.6 Comfort Level

Comfort level controls the air pressure output level. Press Firm button and the output pressure will increase and higher pressure output will support heavier weight patient, for decreasing air pressure, vice versa. Check to see if the suitable pressure is selected by sliding one hand between a deflated air cell and the patient's buttocks areas and there should be minimum contact. Always leave at least 1 inch space between a deflated air cell and patient's buttocks areas to prevent "bottoming-out". Refer to **Table 1 Weight and Comfort Level Reference Table** for recommendation comfort level.



5.1.7 Alarm Mute

Press the alarm mute button to suspend temporarily alarms. Should the situation not resolved and fault conditions continue, the alarm will resume notifying the patient and caregiver.

5.1.8 Alternate/Pulsate Cycle Time Display

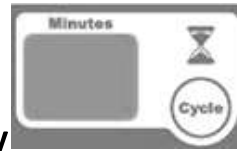

Alternate cycle time can be selected from 5-30 minutes by pressing the Cycle button.

Pulsate cycle time can be selected from 1-20 minutes by pressing the Cycle button.

5.2 OPERATION GUIDE

5.2.1 General Operation:



NOTE:  The power switch is located on the side of the Pump.



- Press  to turn on the unit, all LED indicators on the control panel will light up accompanied with a beep for 2 seconds (check for indicator failure if any), and the indicator of Standby on the control panel will light up. If the Pump was previously shut off in operate mode then the Pump will enter operate mode directly.

P.S. To test the battery, press  to turn off the power and the power failure alarm should be triggered. Refer to **5.2.3 Audiovisual Alarm** if the alarm is not triggered.



- Press the Operate button  and the system will begin to inflate and the "Auto-Firm" indicator will be flashing.
- The mattress should be fully inflated within 10 minutes, and automatically enter the previous operating mode, otherwise the low pressure alarm with warning code "LF" will be triggered.



Note: Do not proceed to other settings before inflation is completed.

- After initial inflation is completed. Press Auto-Firm button  for moving the patient onto the mattress. The mattress will turn into a steady condition in around 5 minutes. Move the patient onto the mattress and press Auto-Firm button  again to cancel Auto-Firm mode and select the appropriate mode.
- According to the weight of the patient, adjust the pressure setting to the most suitable level without "bottoming-out". User can determine an appropriate pressure by adjusting the Comfort Level. Please consult with your physician for a proper setting.

 Warning: the Pump unit should always be operating to prevent bedsores from occurring.

- In operate mode, press operate/standby button  for the system to enter standby mode. The system should be in standby mode before shut down. Switch the power switch  to off and the warning code “S.d.” will appear on the display to shut off the system.



 Note: For reminding purpose, power failure alarm will be triggered if the power is switched off in operating mode (refer to **5.2.3 Audiovisual Alarm**). Press power switch  to restart the system, or press Alarm Mute  to turn off the system (refer **5.2.4 Alarm Mute**).

Table 1 Weight and Comfort Level Reference

Body shape	BARIATRIC Indicator	Comfort Control Indicator	Patient Weight								
			88 40	132 60	176 80	220 100	264 120	308 140	352 160	396 180	(LBS) (KG)
Standard											
Body shape	BARIATRIC Indicator	Comfort Control Indicator	Patient Weight								
			198 90	253 115	308 140	363 165	430 195	507 230	595 270	700 318	(LBS) (KG)
Bariatric											

Body shape	BARIATRIC Indicator	Comfort Control Indicator	Patient Weight								
			88	132	176	220	264	308	352	396	(LBS)
			40	60	80	100	120	140	160	180	(KG)
Standard											
Bariatric											

Protekt® Aire 9900 & 81090-42, 81090-48, 81090-54, 81090-60

5.2.2 CPR

- When CPR needs to be performed, quickly rotate the CPR valve to “OPEN” position, at the same time, disconnect the hose connector from the Pump to speed up the air release.

5.2.3 Audiovisual Alarm

- Power Failure – When electrical shortage occurred or power cord is unplug without turning off the Pump or is pressed (intentionally or unintentionally), the “Power Failure” indicator will light up along with buzzer and will last 20 minutes.

NOTE: When the Pump has not been used for more than 3 months, the Pump may need 6 hours or more of operating time for the alarms to function properly.

- Low Pressure –When an abnormal low pressure occurred in body section for 10 seconds after the pressure is below the abnormal pressure threshold, the "Low Pressure" indicator will flash and beep. Should the situation not be resolved and fault conditions continue, the alarm will resume.
- Service (Malfunction) –When fault conditions occur, the "Service" indicator will light up along with buzzer.













Note: Refer to **Table 2 for Warning Code Reference Table** if error code

*appears on the display or refer to **10. TROUBLESHOOTING.***

5.2.4 Alarm Mute

- When alarms are triggered, both LED light and buzzer will turn on to warn the patient and caregiver. By pressing the button, it will temporarily mute the buzzer so the caregiver may check for possible causes. Should the situation not resolved and fault conditions continue, the alarm will resume. Refer to **10. TROUBLESHOOTING** for diagnosis.
- During “power failure”, pressing “alarm mute” will cease all buzzers and indicators and turn off the system.
- During “low pressure alarm” if the pressure resumes back to normal then the low pressure alarm will stop.
- When more than one alarm is triggered, the alarm will be performed according to priority level. Refer to **Table 2 Warning Code Reference Table** for priority level.

Table 2 Warning Code Reference

PRIORITY HIHG ↓ LOW	WARNING CODE	INDICATOR LED	AUDIBLE OUTPUT MODE	CONDITION OF OUTPUT	WARNING DESCRIPTION	REMARKS
0	N/A	N/A	ONCE	Not in System Shutdown	Key Tone	Key Tone from Functional Button
1		Power Failure	ONCE	POWER-OFF	System Shutdown	Shutdown
2		ALL LED	ONCE	OPERATE OR STANDBY	Power-On	All Indicators Light On
3	N/A	N/A	ONCE	OPERATE OR STANDBY	State/Mode Switching	No Display
4		Auto Firm	ONCE	OPERATE	Mattress Inflation Completion	Inflation Ended
5		Auto Firm	ONCE	OPERATE	Auto-Firm Completion	Auto-Firm Ended
6	N/A	Power Failure	REPEAT (Cycle 4 sec.)	POWER-OFF	Power Failure Alarm	No Display
7		Low Pressure	REPEAT (Cycle 4 sec.)	OPERATE OR STANDBY	Power-On Inflation Failure Alarm	Inflate Failure
8		Low Pressure	REPEAT (Cycle 4 sec.)	OPERATE OR STANDBY	Auto-Firm Failure Alarm	Auto-Firm Failure
9		Low Pressure	REPEAT (Cycle 4 sec.)	OPERATE OR STANDBY	Low Pressure Overtime Alarm	Low Pressure
10		Service	REPEAT (Cycle 4.5 sec.)	OPERATE OR STANDBY	High Pressure Overtime Alarm	High Pressure
11		Service	REPEAT (Cycle 4.5 sec.)	OPERATE OR STANDBY	High Ambient Temperature Alarm	High Temperature
12		Service	REPEAT (Cycle 4.5 sec.)	OPERATE OR STANDBY	Air Valve 1 Positioning Failure Alarm	Air Valve 1 failure
13		Service	REPEAT (Cycle 15 sec.)	OPERATE OR STANDBY	Battery Low Alarm	Battery would need to be replaced
14		NONE	NONE	FACTORY CALIBRATION MODE	Calibration Not Completed	Calibration Unfinished
15		NONE	NONE	FACTORY CALIBRATION MODE	Calibration Completed	Calibration Completed

5.2.5 Lift-Up Detection

- Fowler Mode will be triggered and increase the output pressure to its maximum in static mode when the upper half of the mattress is elevated and exceeded an angle of 45° (±15°) or more. The Pump unit will resume to previous setting when it's lowered than an angle of 45° (±15°).

6. CLEANING

Wipe the Pump unit with a damp cloth pre-soaked with a mild detergent, and keep the Pump unit away from dust. If other detergent is used, choose one that will have no chemical effects on the surface of the plastics case of the Pump unit.



CAUTION: Do not immerse or soak the Pump unit.

Clean the mattress cover by using single use wipes with a solution of neutral detergent and hand hot water. Rinse thoroughly with clean water and damp dry the mattress using single use wipes.

Disinfecting the cover

If the cover is heavily soiled or has been exposed to bodily fluids such as blood, it will require a more thorough cleaning procedure.

Use single use wipes with a 0.1% chlorine solution (1,000ppm) and cold water to wipe the cover. If the cover requires heavier cleaning, use a 1% chlorine solution (10,000ppm) and cold water to wipe the cover. Rinse thoroughly with clean water and damp dry the mattress using single use wipes. Ensure the cover is completely dried before refitting to the mattress.

Frequent or prolonged exposure to higher concentration disinfectant solutions may prematurely age the fabric cover of mattresses. Cover surfaces should be protected during use and rinsed and dried thoroughly after disinfectant.

Laundering

- Before laundering, mattress cover should be completely removed.
- Remove Lift-Up Detection Sensor located on the bottom base before laundering.
- Mattress covers can be laundered as following:
 - Pre wash 140°F + 15 minutes
 - Main wash 140°F + 15 minutes
- This should be followed by a cold rinse and extraction.
- Lift-Up Detection Sensor is not washable. It can be wiped as described, and install back after the mattress is completely dry.

Drying

Mattress covers should be hung from a line or bar and drip dried in a clean indoor

environment. Covers must be completely dried before refitting to the mattress.

Mattress covers can be tumble dried on a low heat setting for 90 minutes. Drying temperature must not exceed 40°C. Exceeding the temperature can cause significant damage to the mattress cover.

 **CAUTION:** Do not use phenolic-based product for cleaning.

 **CAUTION:** After cleaning, dry the mattress without direct exposure of sunlight.

7. STORAGE

- To quickly vacuum air out from mattress for storage, rotate the CPR valve to OPEN position and disconnect the hose connector to release the air.
- Lay the mattress out flat and upsides down.
- Roll from the head end towards the foot end.
- Packing strap can then be stretched around the rolled mattress to prevent unrolling.
- The power cord could be wrapped around the Pump bumper or disconnected for storage.

8. MAINTENANCE

General

- Check main power cord and plug if there are abrasions or excessive wears.
- Check mattress cover for signs of wear or damage. Ensure mattress cover and tubes are stubbed together correctly.
- Check the air hoses for any kink or break. For replacement, please contact your local dealers.

Fuse replacement

- Disconnect the plug from the power outlet when a blown fuse is suspected.
- Remove the cover of the fuse holder by means of a small screwdriver.
- Insert a new fuse of the correct rating in, and replace the cover of the fuse holder back. The fuse rating should comply with the requested specification.

Air Filter Replacement

After checking **10. TROUBLESHOOTING**, if the air filter needs to be replaced:

- Replace the air filter located at the back of the Pump.
- The filter is reusable and can be washed gently with a mild detergent and water. Dry the filter before use.
- Check and replace air filter regularly if environment is dirty.

9. THE DISPOSAL OF AIR MATTRESS

When the air mattress is broken or no longer be useable, the mattress and the Pump may be discarded for recycle.

10. TROUBLESHOOTING

PROBLEM	SOLUTION
The mattress is not able to connect with the Pump	<ul style="list-style-type: none"> ● Check if the mattress model (model no. located inside the cover by the foot end) xxAAAxX matches with the Pump model xxBBB-xxx. The AAA should be the same as BBB. If not, please contact with the agent or distributor. ● Check if the Transport Cap is removed and make sure the connector is not broken.
The Pump is showing no indications of working	<ul style="list-style-type: none"> ● Check if the plug is connected to the mains supply. ● Check if the power switch is switched to ON position (press ). ● Check if there is any blown fuse.
Power failure alarm failed	<ul style="list-style-type: none"> ● If the Pump is in operation but failed to trigger the power failure alarm during power off. Charge the Pump for 6 hours or more of operating time and if the power failure still not works then please contact the dealer or agent for further investigation.
The low pressure light is constantly flashing and the alarm is sounded	<ul style="list-style-type: none"> ● Check if the CPR is at CLOSE position ● Check if the connection between air tubes to Pump unit is tightly secured. ● Check if all coupling connections along mattress are secured. ● If the mains supply is normal but there is no sound of the Pump, please remove the connector from the Pump to check if there's air comes out. If not, please turn off the machine and contact the dealer or agent for further investigation. ● If all of above steps have been checked. Press "Alarm Mute" for system to be verified again.
The Pump is on but the mattress is not alternated	<ul style="list-style-type: none"> ● Ensure the mattress inflation is completed. ● Check the Pump control panel the indicator of "Alternate" should be lighted on, if not, switch it to "Alternate." ● Check if "Service" alarm indicator is on with buzzer, if yes, contact the dealer or agent for further investigation.
Service (Malfunction) Alarm is on	<ul style="list-style-type: none"> ● Press "alarm mute" for system to be verified again. If the alarm is still on, please contact dealer or agent.
The Pump is operating noisily	<ul style="list-style-type: none"> ● Make sure the Pump is resting against a solid surface. ● If the noise is getting louder, contact the dealer or agent for further investigation.
Patient is bottoming out (without alarm triggered)	<ul style="list-style-type: none"> ● Pressure setting might be inadequate for the patient, adjust comfort level to FIRM (refer to Table 1 Weight and Comfort Level Reference Table) and wait for a few minutes for better comfort. ● Follow the procedures "The low pressure light is constantly flashing and the alarm is sounded" for inspection.

If the above information does not solve the problem, please contact your local dealer or agent for further support.

11. TECHNICAL DATA

11.1 Product Specification

Pump Unit		Air Mattress	
Model	81090	Model	8" Air Mattress
Dimension (cm)	40(L)x 17.5(W)x 27.5(H)	Dimension (cm)	200(L)x 90(W)x 20(H) 200(L)x 107(W)x 20(H) 200(L)x 122(W)x 20(H) 200(L)x 137(W)x 20(H) 200(L)x 153(W)x 20(H)
Weight (kg)	6.5	Weight (kg)	7.0(81090-36) 7.4(81090-42) 7.9(81090-48) 8.4(81090-54) 9.0(81090-60)
Alternate Cycle Time (minutes)	5—30	No. of Air Cell	18 cells
Pulsate Cycle Time (minutes)	1—20		
Auto Firm Time (minutes)	20		
Pump output flow range (LPM)	1275L	Cell Material	Nylon-TPU
Pressure Range (mmHg)	20—46 (±5)		
Power	AC120V 60Hz	Cover Material	Nylon-PU with Quilted
Current	4.8 A _{MAX} (@132V~)	Bottom Material	Polyester-PU
Fuse Rating	T5A 250VAC		
Classification	Class I (MOOP)	Standard Max. Weight(kg)	180
	Type BF  (MOPP)	Bariatric Max. Weight(kg)	450
Warranty	2 year	Warranty	2 year

Environment Condition

Operation Environment	5°C—35°C 15%RH ~ 93%RH(No Condensation)
Storage Environment	-25°C—70°C ≤93%RH(No Condensation)
Environment Pressure	70 kPa—101.3 kPa
Environment Humidity	≤93%RH

11.2 EMC INFORMATION (230V)

Guidance and manufacturer's declaration-electromagnetic emissions		
<p>The system is intended for use in the electromagnetic environment specified below.</p> <p>The customer or the user of the system should assure that it is used in such an</p>		
Emission test	Compliance	Electromagnetic environment-guidance
RF emissions CISPR 11	Group 1	The system uses RF energy only for its internal function. Therefore, its RF emissions are very low and are not likely to cause any interference in nearby electronic equipment.
RF emissions CISPR 11	Class B	The system is suitable for use in all establishments, including domestic establishments and those directly connected to the public low-voltage power supply network that supplies buildings used for domestic purposes.
Harmonic emissions IEC 61000-3-2	Class A	
Voltage fluctuations /flicker emissions IEC 61000-3-3	Compliance	

Guidance and manufacturer's declaration–electromagnetic immunity

The system is intended for use in the electromagnetic environment specified below.

The customer or the user of the system should assure that it is used in such an environment.

Immunity test	IEC 60601 test level	Compliance level	Electromagnetic environment-guidance
Electrostatic discharge(ESD) IEC 61000-4-2	± 6 kV contact ± 8 kV air	± 6 kV contact ± 8 kV air	Floors should be wood, concrete or ceramic tile. If floors are covered with synthetic material, the relative humidity should be at least 30%
Electrical fast transient/burst IEC 61000-4-4	± 2kV for power supply lines ± 1kV for input/output lines	± 2kV for power supply lines Not applicable	Mains power quality should be that of a typical commercial or hospital environment.
Surge IEC 61000-4-5	± 1kV line(s) to line(s) ± 2kV line(s) to earth	± 1kV differential mode Not applicable	Mains power quality should be that of a typical commercial or hospital environment.
Voltage Dips, short interruptions and voltage variations on power supply input lines IEC 61000-4-11	<5% UT(>95% dip in UT) for 0,5 cycle 40% UT(60% dip in UT) for 5 cycles 70% UT(30% dip in UT) for 25 cycles <5% UT(>95% dip in UT) for 5 s	<5% UT(>95% dip in UT) for 0,5 cycle 40% UT(60% dip in UT) for 5 cycles 70% UT(30% dip in UT) for 25 cycles <5% UT(>95% dip in UT) for 5 s	Mains power quality should be that of a typical commercial or hospital environment. If the user of the system requires continued operation during power mains interruptions, it is recommended that the system be powered from an uninterruptible power supply or a battery.
Power frequency(50/60 Hz) magnetic field IEC 61000-4-8	3 A/m	3 A/m	The system power frequency magnetic fields should be at levels characteristic of a typical location in a typical commercial or hospital environment.

NOTE UT is the a.c. mains voltage prior to application of the test level.

Guidance and manufacturer's declaration–electromagnetic immunity

The system is intended for use in the electromagnetic environment specified below.

The customer or the user of the system should assure that is used in such and environment.

Immunity test	IEC 60601 test level	Compliance level	Electromagnetic environment-guidance
<p>Conducted RF IEC 61000-4-6</p>	<p>3 Vrms 150 KHz to 80 MHz</p>	<p>3 Vrms</p>	<p>Portable and mobile RF communications equipment should be used no closer to any part of the system including cables, than the recommended separation distance calculated from the equation applicable to the frequency of the transmitter.</p> <p>Recommended separation distance:</p> $d = 1,2 \sqrt{P}$ <p>$d = 1,2 \sqrt{P}$ 80MHz to 800 MHz</p> <p>$d = 2,3 \sqrt{P}$ 800MHz to 2,5 GHz</p> <p>Where P is the maximum output power rating of the transmitter in watts (W) according to the transmitter manufacturer and d is the recommended separation distance in metres (m).</p>
<p>Radiated RF IEC 61000-4-3</p>	<p>3 V/m 80MHz to 2,5 GHz</p>	<p>3 V/m</p>	<p>Field strengths from fixed RF transmitters, as determined by an electromagnetic site survey,^a should be less than the compliance level in each frequency range.^b</p> <p>Interference may occur in the vicinity of equipment marked with the following symbol:</p> 

NOTE1 At 80 MHz and 800 MHz, the higher frequency range applies.

NOTE2 These guidelines may not apply in all situations. Electromagnetic propagation is affected by absorption and reflection from structures, objects and people.

a Field strengths from fixed transmitters, such as base stations for radio (cellular/cordless) telephones and land mobile radios, amateur radio, AM and FM radio broadcast and TV broadcast cannot be predicted theoretically with accuracy. To assess the electromagnetic environment due to fixed RF transmitters, an electromagnetic site survey should be considered. If the measured field strength in the location in which the system is used exceeds the applicable RF compliance level above, the system should be observed to verify normal operation. If abnormal performance is observed, additional measures may be necessary, such as re-orienting or relocating the system.

b Over the frequency range 150 kHz to 80 MHz, field strengths should be less than 3 V/m.

**Recommended separation distance between
portable and mobile RF communications equipment and the system**

The system is intended for use in an electromagnetic environment in which radiated RF disturbances are controlled. The customer or the user of the system can help prevent electromagnetic interference by maintaining a minimum distance between portable and mobile RF communications equipment (transmitters) and the system as recommended below, according to the maximum output power of the communications equipment.

Rated maximum output power of transmitter W	Separation distance according to frequency of transmitter m		
	150 kHz to 80 MHz $d = 1,2\sqrt{P}$	80 MHz to 800 MHz $d = 1,2\sqrt{P}$	800 MHz to 2,5 GHz $d = 2,3\sqrt{P}$
0,01	0,12	0,12	0,23
0,1	0,38	0,38	0,73
1	1,2	1,2	2,3
10	3,8	3,8	7,3
100	12	12	23

For transmitters rated at a maximum output power not listed above, the recommended separation distance d in metres (m) can be estimated using the equation applicable to the frequency of the transmitter, where p is the maximum output power rating of the transmitter in watts (W) according to the transmitter manufacturer.

NOTE1 At 80 MHz and 800 MHz, the separation distance for the higher frequency range applies.

NOTE2 These guidelines may not apply in all situations. Electromagnetic propagation is affected by absorption and reflection from structures, objects and people.