



**PROTEKT® TAKE-A-LONG  
FOLDING ELECTRIC PATIENT LIFT  
MODEL: 33400P**



**OWNER'S MANUAL**

270 Washington Street  
Mount Vernon, NY 10553  
855-237-7622  
[www.proactivemedical.com](http://www.proactivemedical.com)

## **Thank you for choosing the Protekt<sup>®</sup> Take-A-Long Lift!**

To better serve you, please record the following information:

Supplier Name : \_\_\_\_\_

Telephone : \_\_\_\_\_

Serial # : \_\_\_\_\_

Date of Purchase : \_\_\_\_\_

### **INSPECT YOUR MERCHANDISE**

Upon receipt of your patient lift, verify that all merchandise is complete and free from any shipping damage. Refuse delivery if the packaging appears to be badly damaged. If the merchandise is received damaged or is missing components, contact the shipping company immediately and file a claim.

For further assistance, contact your local dealer or Proactive Medical Products at the following:

Proactive Medical Products  
270 Washington Street  
Mount Vernon, NY 10553  
Tel: 855-237-7622  
[www.proactivemedical.com](http://www.proactivemedical.com)

# Features Chart:

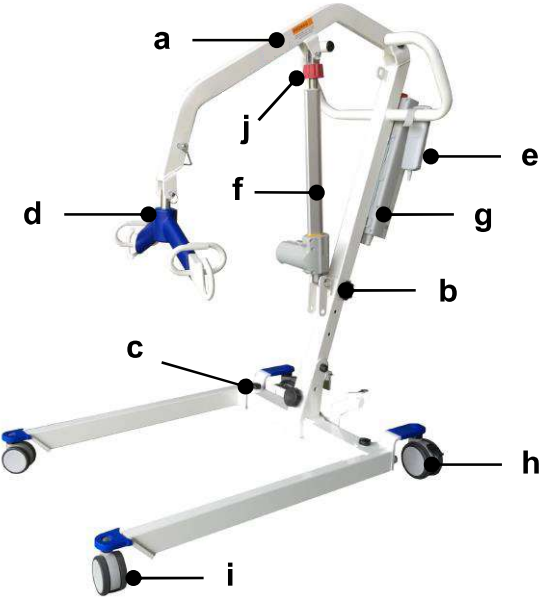

- a. Boom
- b. Mast
- c. Base
- d. Spreader bar
- e. Pendant
- f. Actuator
- g. Control box
- h. Caster with brake
- i. Front caster
- j. Emergency Lowering Device

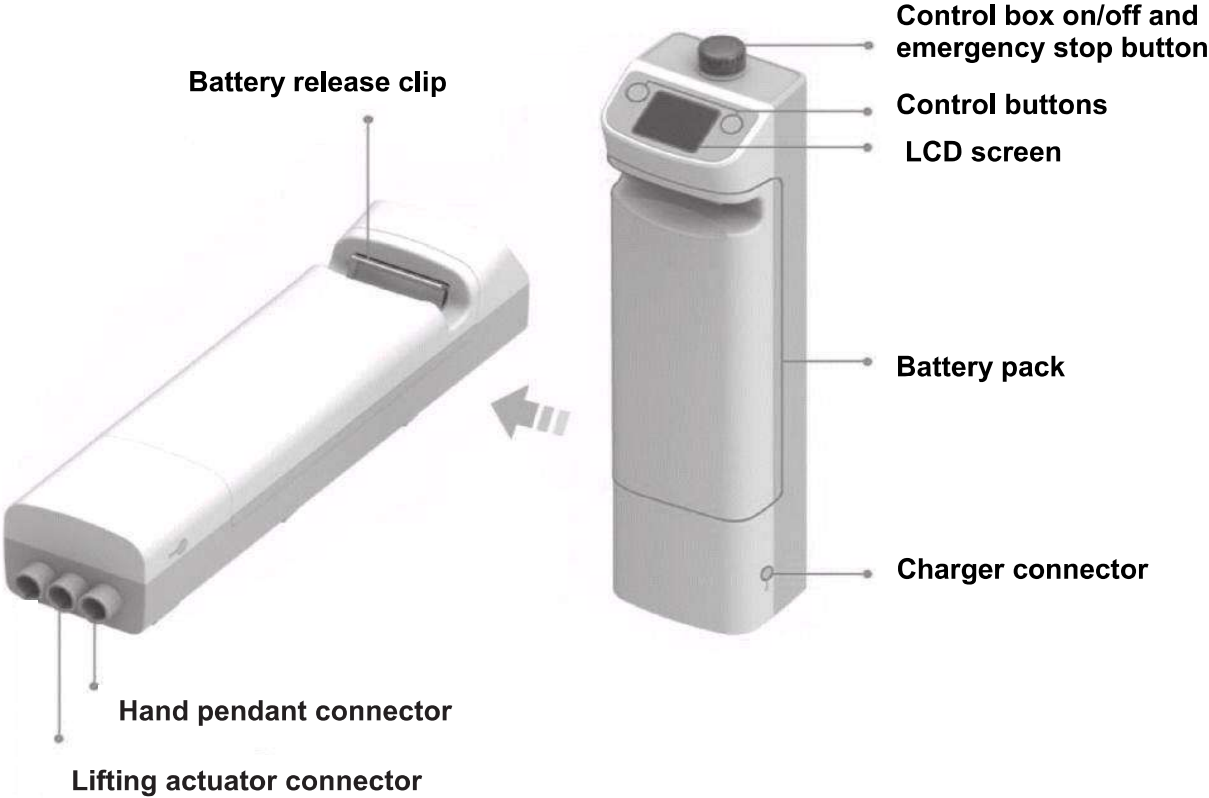

## **SAFETY INSTRUCTIONS**

The Protekt® Take-A-Long 33400P patient lift reflects innovative state of the art design to increase user mobility. Your Protekt® lift will provide years of service if it is properly maintained as any piece of electrical/mechanical equipment requires.

Please pay careful attention to the following important information regarding the care, maintenance, and operation of the Protekt® Take-A-Long 33400P patient lift. Carefully read these instructions before assembling the lifter or attempting to lift any user with the device.

### **PLEASE NOTE THE FOLLOWING:**

- Special care must be taken with users/patients who cannot themselves provide assistance while being lifted. (i.e. patients who are comatose, spastic, agitated, or otherwise severely handicapped).
- The Protekt® Lift 33400P should be used solely for transferring a user/patient from one utility (beds, chairs, toilets, etc.) to another. The patient lift should not be used for transporting or moving any patient from one location to another location.
- During lifting or lowering, whenever possible, always keep the base of the lift in the widest position.
- The base of the lift should be closed before moving the lift.
- Do not roll casters over any object while the user/patient is in the sling.
- Do not lock casters during lifting.
- While being lifted in a sling, always keep the user/patient centered over the base and facing the caregiver operating the lifter.
- Maximum weight that can be safely lifted is 400 pounds.
- Never leave the user/patient unattended during lifting.

The Protekt® Take-A-Long 33400P lift allows a person to be lifted and transferred safely, with minimum physical effort provided by the caregiver. Before attempting to lift anyone, please practice operating the lift. Also prior to actual lifting, explain the lifting procedure to the user/patient.

## **WARNING!**

Do not attempt to transfer a patient without prior approval of the patient's primary caregiver. Also, do not transfer without having studied the instructions and practiced operating the lift and sling several times. Together with the patient's doctor, nurse, or medical attendant, select a sling that is both practical and comfortable. The sling selected should be one that serves the needs of the patient, while providing the patient with optimal safety. Never interfere with the lift, unless instructed by the attendant. Have a doctor, nurse, or medical attendant (experienced in the use of the **Protekt® Lift 33400P**) present during the first few times the lift is used to transfer a new user.

## **WARNING!**

Proactive Medical slings are specially designed to be used in conjunction with Proactive lifts. Do not use slings manufactured by other companies with any of Proactive Medical's equipment. **USING OTHER MANUFACTURER'S SLINGS ON THIS EQUIPMENT IS UNSAFE AND MAY RESULT IN SERIOUS INJURY TO USERS AND CAREGIVERS. PROACTIVE MEDICAL** is not responsible for any consequence resulting from the use of non-Proactive slings on this equipment.

## **WARNING!**

Do not put anything (e.g. cushion, pad, etc.) between the user and the sling. This may cause the user/patient to slide out of the sling and cause injury.

## **WARNING!**

Avoid personal injury by making sure no children or pets are near the **Protekt® Lift 33400P** while it is being used.

## **WARNING!**

Avoid personal injury by making sure all extremities (such as fingers, arms, legs, or feet) are clear of the lift mechanism while it is in operation.

## **WARNING!**

**Avoid personal injury and possible damage to the Protok<sup>®</sup> Lift 33400P by making sure the maximum weight limit of 400 lbs. is not exceeded.**

## **WARNING!**

**Replace any worn parts with only genuine Proactive Medical parts. The patient lift parts are not interchangeable with parts from other patient lift brands. Using other patient lift parts on these products is unsafe and may result in serious injury to user and caregiver. Proactive Medical is not responsible for any consequence resulting from the use of non-Proactive parts and components.**

## **WARNING!**

**Avoid personal injury by making sure the battery charger is disconnected before conducting any electrical inspection. Contact your dealer if any electrical problem is detected.**

## **WARNING!**

**Service and repair of this equipment should be performed only by an authorized dealer. Proactive Medical is not responsible for any consequence resulting from any unauthorized service or repair.**

## **CAUTION**

**Avoid damage to the Protok<sup>®</sup> Lift 33400P by keeping foreign objects from coming into contact with the lift mechanism.**

## **NOTE**

**Arrange all necessary items (lift, slings, commode chair or wheel-chair) for a smooth procedure. The user/patient being transferred should be positioned in the center of the bed before being lifted, as well as when he/she is returned to the bed. Keep lifter base widened and brakes unlocked during lifting.**

# ASSEMBLY INSTRUCTIONS

## WARNING!

The lift is heavy! Therefore, avoid injury and **DO NOT** attempt to remove the lift from the box without any assistance.

Assemble the patient lift in accordance with the following instructions:



- Step 1.** Engage the brakes. Remove the **Black Hand nut** from the bottom of the mast and QR pin from the bottom of the Mast and Base. Pull the Mast, Boom and Spreader Bar to an upright position. Re-insert the QR pin into the holes at the bottom of the Mast and then use the Black (no tool) Hand Nut to secure the Mast in place and make sure the Hand Nut is holding the Mast securely.

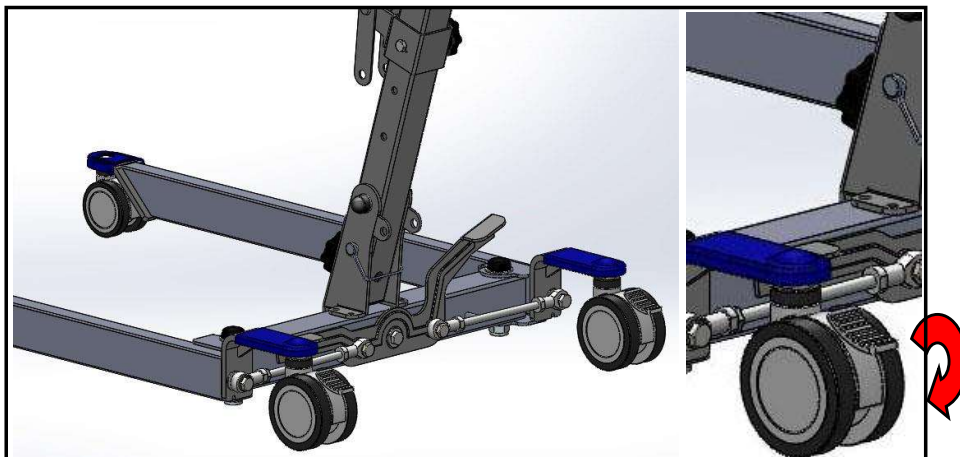

**Step 2.** A. Remove another QR pin which is connected to the bottom of Actuator and Boom. Leave the QR pin on Boom as below left picture.

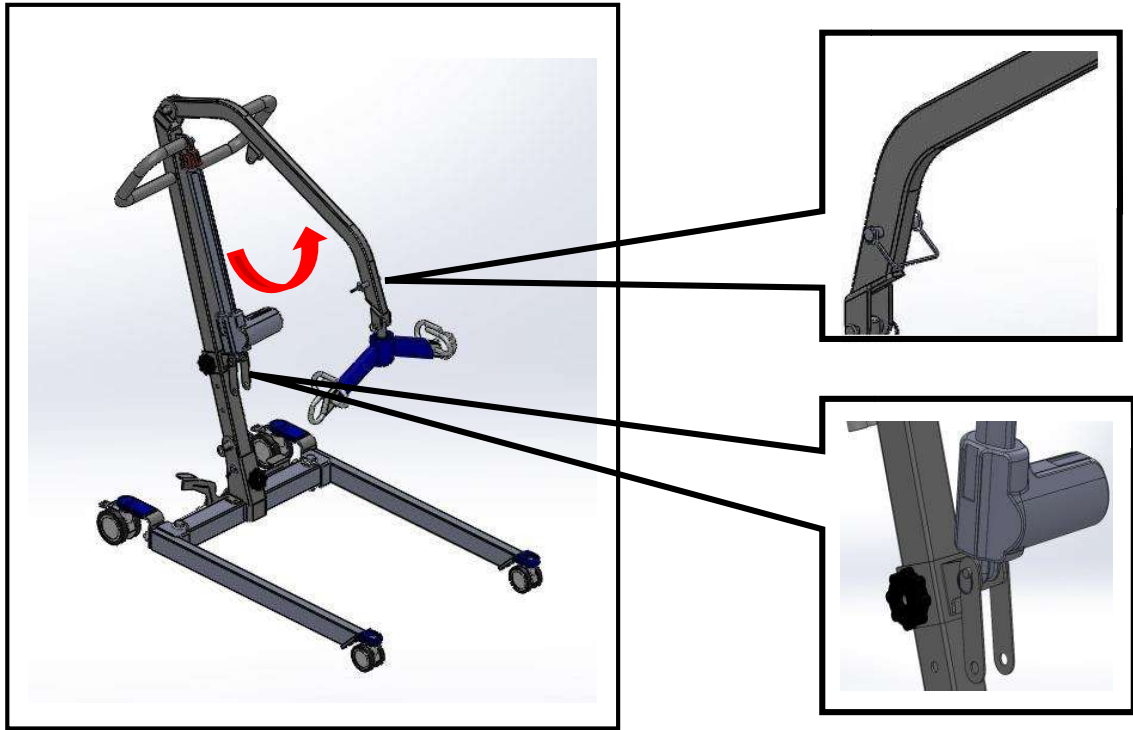

B. Attach the top of the Actuator to the bracket on the Boom and insert pin. Insert keeper ring through hole in pin to secure actuator to upper bracket.

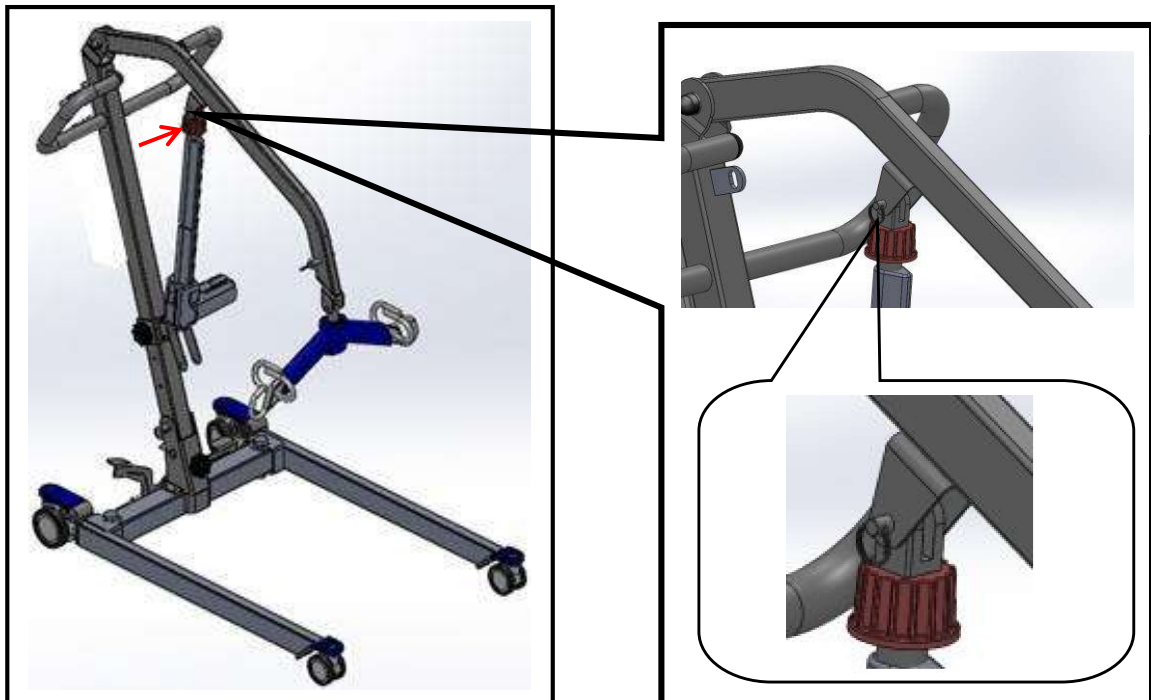



**Step 3.** Attach the Control Box to the Mast and tighten two screws.

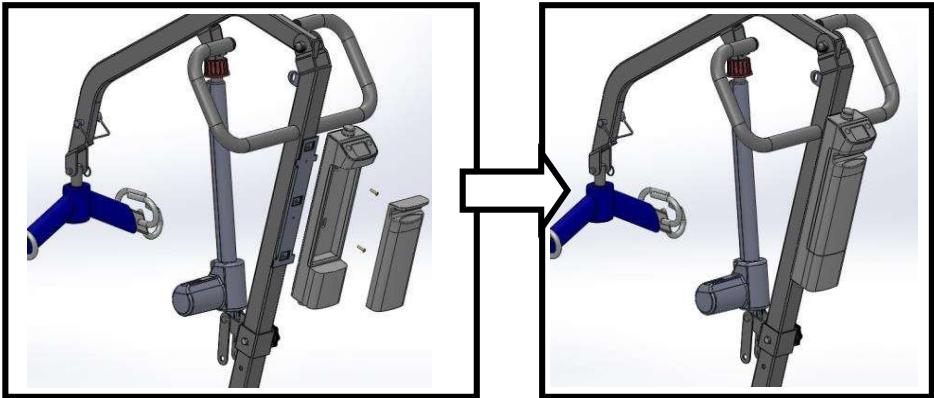

**Step 4.** Insert the Actuator plug into the Control Box.

**Step 5.** Insert the Pendant plug into the Control Box.

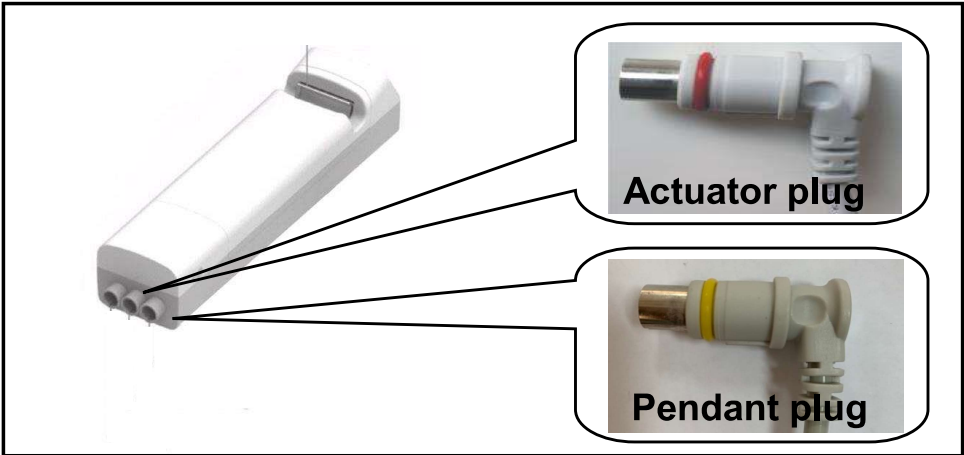

**NOTE:**  
Prior to using the Protekt® Lift 33400P, charge the batteries for 10-12 hours.

## MAINTENANCE & INSPECTION CHECK LIST

The operator is to inspect the Protekt® Take-A-Long Lift 33400P prior to each use. Check all bolts for tightness. Make sure the base can be easily widened, and that all lift parts are in place. Make sure all casters turn freely, and that the caster brakes can be engaged. Make certain all necessary items (i.e. slings, wheel chairs, etc.) are accessible and ready for use.

At least once a month, the lift should be thoroughly inspected by a person qualified to recognize any signs of wear, and looseness of bolts or parts. Replace any worn parts immediately.

To lubricate, place a drop of oil on the following points when the Protekt® Lift 33400P is serviced and every month thereafter - Top of Mast, Spreader Hinge, and Caster Axles.

### REPLACEMENT PARTS

LP-33400P-HPK	Replacement Hardware Pack f/ Protekt 33400P Lift
LP-33400P-TA1-ACT	Replacement Actuator f/ Protekt Take-A-Long Folding Lifter 33400P (400lb Cap.)
LP-FC-33400P	Replacement Front Caster f/ Protekt Portable Lift 33400P
LP-RC-33400P	Replacement Rear Caster f/ Protekt Portable Lift 33400P
LP-TBC2-CRDL	Battery Charger Cradle ONLY (no plug) f/ Protekt Lift/Stand
LP-TBC2-CRDL-PK	Battery Charger Cradle Pack (includes plug) f/ Protekt Lift/Stand
LP-TC12-BPAK	Replacement Battery Pack f/ Protekt Lift/Stand
LP-TC12-CBOX	Replacement Control Box f/ Protekt Lift/Stand
LP-TMH3-PEN	Replacement Hand Pendant f/ Protekt Lift/Stand
LP-TP7C-ADP	Replacement Plug f/ Protekt Lift/Stand

# USER GUIDE

## CHARGING THE BATTERY -

The lift can be charged by plugging the charger directly into the control box while it is attached to the lift.

**Or**

The battery pack can be charged while seated in the (optional) wall/ desk charging caddy.

## OPERATING INSTRUCTIONS — USING THE CONTROL BOX

1. If you press either control button (shown at right) for less than 0.5 seconds, you can access the screens shown below.

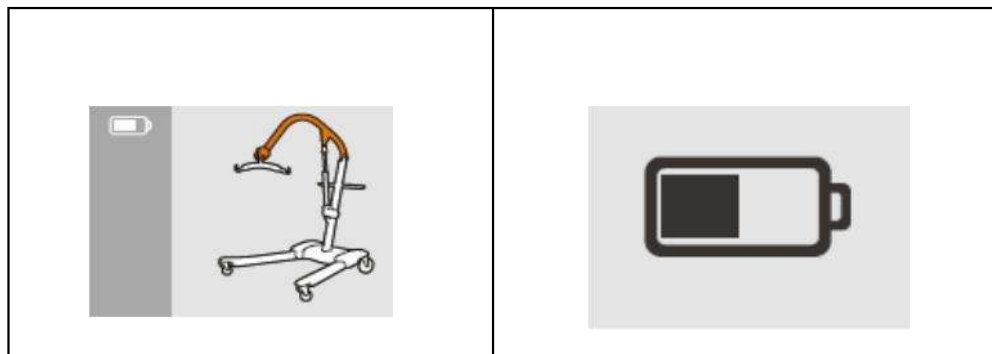
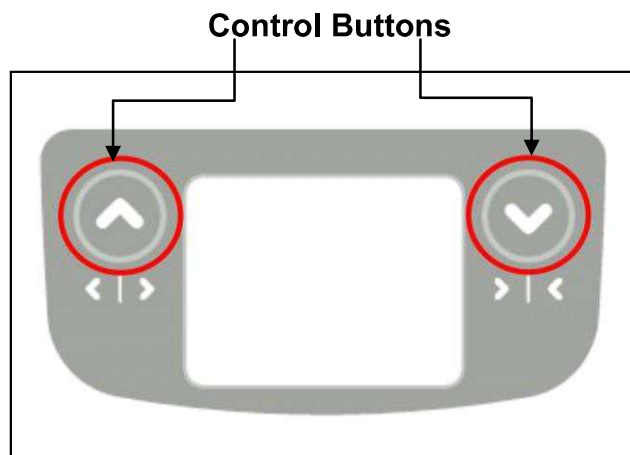

- 2.



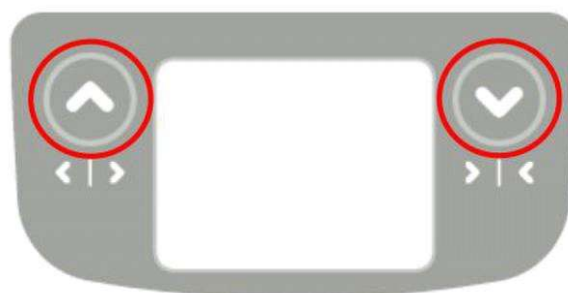

### **L - Left button**



Pressing the left button for more than 0.5 seconds will begin actuator extension.

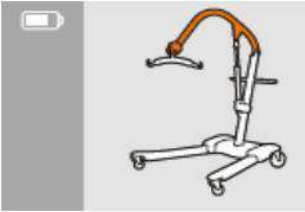

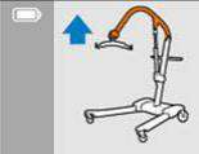
### **R - Right button**





Pressing the right button for more than 0.5 seconds will begin actuator retraction.

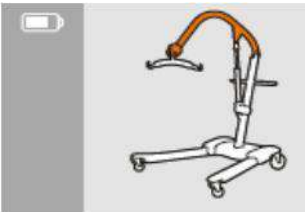

Raise / Lower Lift	
	<p>Long press to raise lift </p> <p>Long press to lower lift </p>
	 

3. Press the  button to raise or the  button to lower the lift.

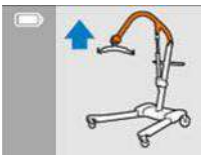
## OPERATING INSTRUCTIONS — USING THE HAND PENDANT



Raise / Lower Lift	
	<p>Long press to raise lift </p> <p>Long press to lower lift </p>
	 

1. Press the  button to raise or the  button to lower the lift .

## MAINTENANCE SCHEDULE

Item	In the Beginning	Monthly	Every 3 Months
<b>Boom &amp; Spreader Bar:</b> Check connections between 1) Boom and Spreader Bar and 2) Boom and Mast for improper connection, looseness, or wear.  Check the Boom for bending and deflection.	●	●	
<b>Mast:</b> Check the Mast for bending or deflection.  Check the steering bar for damage or loose screws.	●	●	
<b>Base &amp; Foot Peddle:</b> Check bolts and nuts for looseness.  Check casters and axle bolts for tightness.  Check rubber parts on the casters for deflection.  Apply grease to caster ball bearings if needed.	●	●	●
<b>Cleaning:</b> As needed.			●
<b>Actuator &amp; Control Box:</b>  Make sure the control box is firmly affixed to the mast.  Make sure the pins firmly affix the actuator to the Boom and the Mast.	●	●	
Make sure the connecting cable of the actuator and the control box is not loose.  Make sure the Battery has capacity prior to use.	●	●	
<b>Slings &amp; Sling Hardware:</b>  Check sling for wear.  Check sling hardware every time before use.	●	●	

## OPERATING INSTRUCTIONS

**NOTE: Turn the lift “ON” by turning the red “RESET” button clockwise. Turn the lift “OFF” by pressing down the “RESET” button.**

### Transfer From Bed

- User/patient should be in the center of the bed.
- Position user onto his/her side by rolling user towards you.
- Roll the sling in half, approximately. The handle on the back section should face outward when the sling is fitted.
- Position the sling under the user/patient so the commode aperture aligns with the base of the spine and top of the sling close to the neck.
- Roll user onto the opposite side and position him/her on the flat section of the sling. This will allow you to unroll the remainder of the sling from the other side of the user.
- Once the sling has been positioned centrally, feed the leg sections under the thighs and draw them up between the thighs.
- Raise the head of the bed if this function is available.
- Move the lift slowly towards the user and position the spreader bar over the user’s/patient’s chest.
- Attach Loop **a** of the sling to Hook **A** on Spreader Bar; attach Loop **b** to Hook **B**; attach Loop **c** to Hook **C**; attach Loop **d** to Hook **D**.

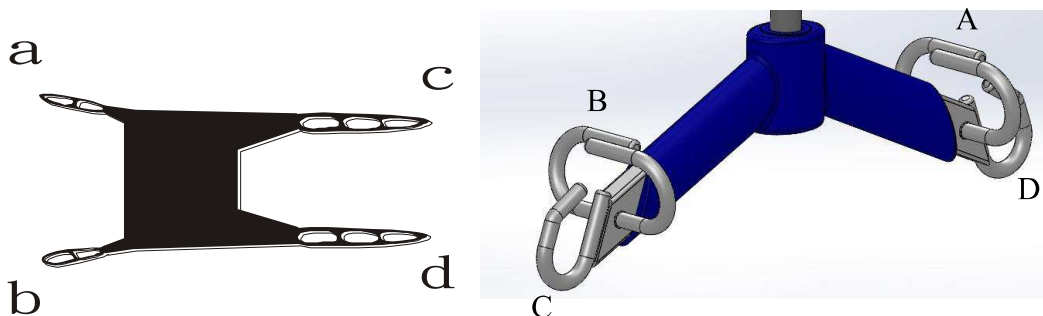

- Lift the user above the bed by using the hand control.
- Pull lift away from bed. Position user over the wheelchair or chair then lower the patient onto the surface.

**Note: Reverse the above procedures when returning the user/patient to bed.**

## **Transfer From Wheelchair**

- Grasp the sling at each corner of the "U" shape of the commode aperture.
- The sling should be fitted with the grab handles on the back section facing outward.
- Help the user lean forward slightly, then slide the sling down between the chair and the user's back.
- Position the commode aperture where the buttocks meets the seat.
- Position the sling equally around both sides of the body.
- Draw the leg sections to the front along the length of the user's thigh.
- Check the sling's central positioning by comparing the lengths of the leg sections when they are drawn forward.
- Reposition the sling if the leg sections are not equal in length.
- Feed the leg sections under the thighs.
- From between the legs, gently pull the leg section up the inner thigh. Feed as much material as possible under and between the thighs. Ensure the leg sections are positioned midway under the thighs to provide good support and greater comfort.
- Move the lift slowly towards the user and position the spreader bar over the user's chest.
- Attach Loop a of sling to Hook A on Spreader Bar; attach Loop b to Hook B; attach Loop c to Hook C; attach Loop d to Hook D.
- Lift patient above the wheelchair by using the hand control.
- Pull lift away from wheelchair. Position patient over bed and lower patient onto it.

**Note: Reverse the above procedures when returning the user/patient to a wheelchair.**

## **WARNING!**

**Use ONLY Proactive Medical slings/products with this equipment.**

## EMERGENCY LOWERING MECHANISM

In case of lift failure while using the Protekt® Lift 33400P, please follow the procedures below to safely lower the user.

The Emergency Lowering Device is located at the top of the actuator shaft. It is intended for use if the actuator fails to operate while a patient is suspended. The device consists of a plastic collar ring that should be turned clock-wise continually until the patient has been lowered.

Contact your dealer immediately if standard troubleshooting techniques do not correct the failure. Do not attempt to lift until all failure issues have been safely resolved.

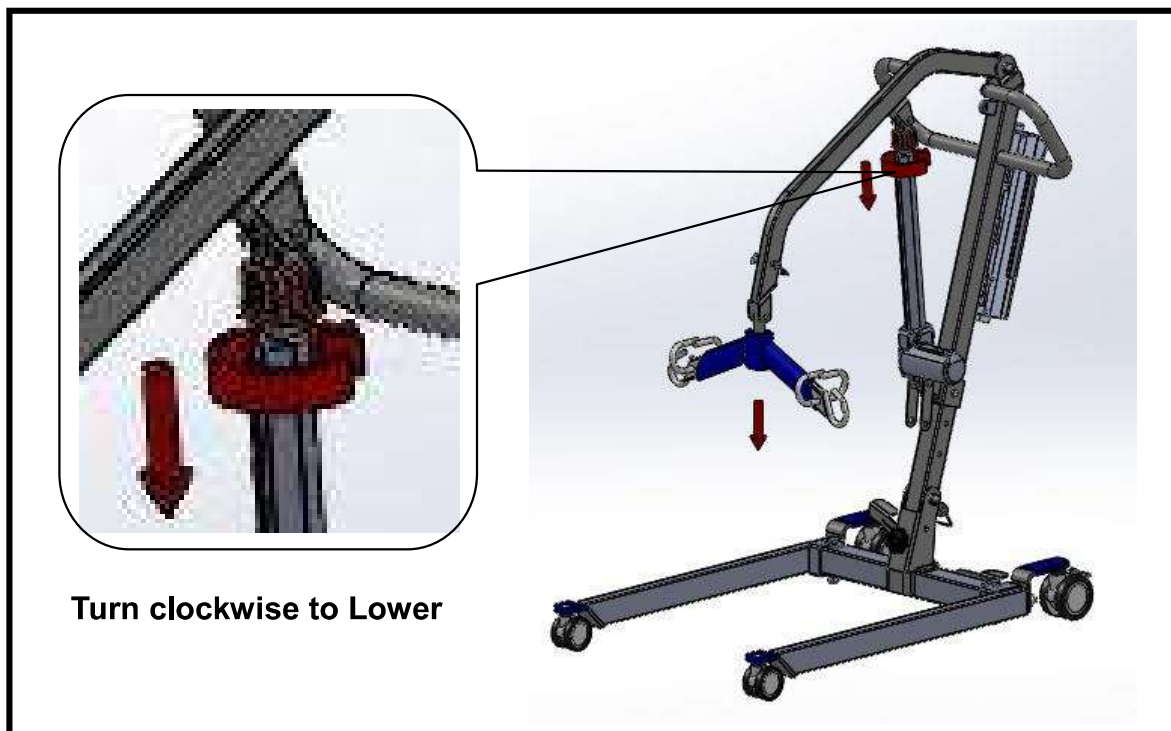

### NOTE:

*THE EMERGENCY LOWERING DEVICE IS INTENDED FOR USE DURING LIFT FAILURE. THIS DEVICE WILL ALLOW LOWERING OF PATIENTS ONLY. PLEASE CONTACT YOUR DEALER IMMEDIATELY IN CASE OF FAILURE.*



## Full Body Mesh Slings

ITEM #	DESCRIPTION
30110 <i>Medium</i>	Mesh full body: medium 600 lb. weight capacity
30111 <i>Large</i>	Mesh full body: large 600 lb. weight capacity
30124 <i>X-Large</i>	Mesh full body: X-large 600 lb. weight capacity
30118 <i>XX-Large</i>	Mesh full body: XX-large 600 lb. weight capacity

## Full Body Mesh Slings w/Commode

ITEM #	DESCRIPTION
30114 <i>Medium</i>	Mesh full body: medium w/commode opening 600 lb. weight capacity
30115 <i>Large</i>	Mesh full body: large w/commode opening 600 lb. weight capacity
30116 <i>X-Large</i>	Mesh full body: X-large w/commode opening 600 lb. weight capacity
30119 <i>XX-Large</i>	Mesh full body: XX-large w/commode opening 600 lb. weight capacity

## Full Body Solid Slings

ITEM #	DESCRIPTION
30112 <i>Medium</i>	Solid fabric full body: medium 600 lb. weight capacity
30113 <i>Large</i>	Solid fabric full body: large 600 lb. weight capacity
30117 <i>X-Large</i>	Solid fabric full body: X-large 600 lb. weight capacity
30123 <i>XX-Large</i>	Solid fabric full body: XX-large 600 lb. weight capacity

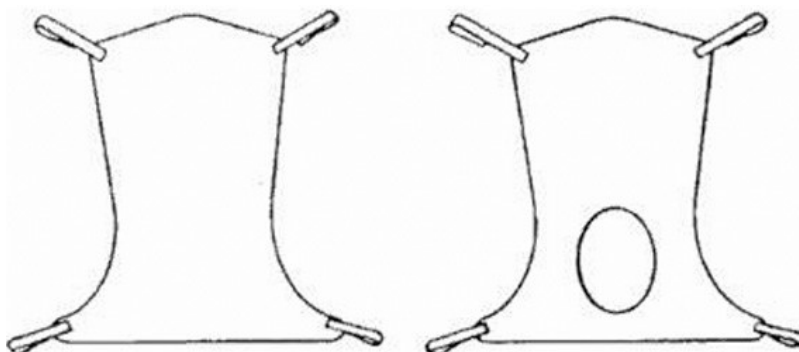

Divided leg design is best suited for high level spinal cord injuries or patients where sling removal is more difficult. Support ranges from the upper back to beneath the thighs. Can be positioned with patient seated. Greatly simplifies the use of bathroom facilities.

## Divided Leg Slings

ITEM #	DESCRIPTION
30100P <i>Small</i>	Solid divided leg: small 450 lb. weight capacity
30100 <i>Medium</i>	Solid divided leg: medium 450 lb. weight capacity
30101 <i>Large</i>	Solid divided leg: large 450 lb. weight capacity
30102 <i>X-Large</i>	Solid divided leg: X-large 450 lb. weight capacity
30103 <i>XX-Large</i>	Solid divided leg: XX-large 600 lb. weight capacity

## Padded Divided Leg Slings w/o Head Support

ITEM #	DESCRIPTION
30100P-NHS <i>Small</i>	Solid padded divided leg w/o head support: small 600 lb. weight capacity
30100-NHS <i>Medium</i>	Solid padded divided leg w/o head support: medium 600 lb. weight capacity
30101-NHS <i>Large</i>	Solid padded divided leg w/o head support: large 600 lb. weight capacity
30102-NHS <i>X-Large</i>	Solid padded divided leg w/o head support: X-large 600 lb. weight capacity

## Padded Divided Leg Slings w/Head Support





ITEM #	DESCRIPTION
30100P-HS <i>Small</i>	Solid padded divided leg w/head support: small 600 lb. weight capacity
30100-HS <i>Medium</i>	Solid padded divided leg w/head support: medium 600 lb. weight capacity
30101-HS <i>Large</i>	Solid padded divided leg w/head support: large 600 lb. weight capacity
30102-HS <i>X-Large</i>	Solid padded divided leg w/head support: X-large 600 lb. weight capacity



# TROUBLESHOOTING CHART

The following list of encountered problems and their solutions will assist you in determining what may be causing your Proactive Medical lift not to function as designed. If you have a problem occurring which is not listed below, contact Proactive Medical or an authorized Proactive distributor for further information. Do not attempt to repair components or parts on your lift, as this may invalidate your warranty or cause further problems that may result in patient injury. Stop using your lift immediately if it is not functioning correctly or any warning beeps are heard.

If any of the following notification signs arise, follow the steps below to troubleshoot:

<p><b>Maintenance Notification:</b> Check the state of the lift and actuators.</p>	<div style="text-align: center;"> <p><b>ATTENTION</b></p>  <p><b>Maintenance Required</b></p> </div>
<p><b>Low Battery Capacity:</b> Recharge battery. If it does not hold an proper charge, the battery will need to be replaced.</p>	<div style="text-align: center;"> <p><b>ATTENTION</b></p>  <p><b>Recharge Or Exchange</b></p> </div>
<p><b>Overload Alarm:</b> Weight has exceeded the set maximum limit. Remove weight from the lift and retry.</p>	<div style="text-align: center;"> <p><b>ATTENTION</b></p>  <p><b>Overloaded</b></p> </div>
<p><b>Force Interference:</b> If any force interferes when the lift is lowered, the lift will stop working to avoid injury to the patient. Remove interference immediately. This image will also appear if the actuator connectors are installed in the wrong positions in the control box. See Assembly Instructions.</p>	<div style="text-align: center;"> <p><b>ATTENTION</b></p>  <p><b>Please Check Hoist</b></p> </div>

**▲ WARNING:** If you experience a problem with your lift and are unable to service it yourself, contact Proactive Medical or your Proactive authorized distributor.

## LIMITED WARRANTY

The Propekt® Take-A-Long Lift you purchased is guaranteed to be free from defects in material and workmanship under normal use and service. The warranty period for this product is 2 Years Electronics/3 Years Frame from the date of purchase by the original purchaser. This warranty shall be voided upon transfer of ownership of this product. Proactive Medical agrees to repair or replace this product, at our discretion and at no charge, within the warranty period provided and that Proactive Medical consents the unit is defective. The repaired or replacement unit shall be warranted for a period equal to the balance of the defective unit's warranty period.

### NOTE:

To ensure the best service to our customers, Proactive Medical requires the following information to be included with the returned unit:

1. Model Name/Number and Serial Number on the packaging.
2. Proof of purchase, i.e. a copy of the original invoice.
3. A Return Authorization number (RA#) obtained by calling Authorized dealer/distributor prior to the return of the product. The RA# must be clearly indicated on the outside of the packaging.
4. A detailed description of the problem and its symptoms on a note.

This warranty shall not apply to any product which has been repaired or altered in any way so as, in our judgment, to affect its functionality and durability, nor to any product subject to abuse, misuse, negligence or accident, improper maintenance, improper installation, nor to any product used with other parts, components and/or accessories with quality and/or specifications not compatible with this product. This warranty does not cover products that have been impaired by occurrences considered Acts of God over which authorized dealer has no control. This warranty shall also be voided if any required periodic maintenance, if applicable, has not been properly performed on this product.

This warranty and the aforementioned remedies presented are exclusive and in lieu of all other express or implied warranties. No other representations or claims shall be binding or obligate authorized dealer in any way. Any warranty applicable to this product is limited to the aforementioned period indicated. In no event shall authorized dealer be liable for any special, incidental, or consequential damages; loss of revenue; or cost of replacement goods; resulting from the use or malfunction of this product to the associated equipment on which and with which it is used. This warranty gives specific legal rights and you may be entitled to other rights that vary from state to state.