

VENTURA

VENTURA



drive[™]

OWNER'S MANUAL

TABLE OF CONTENTS



- I. PREFACE.....3
- II. SAFETY NOTICES..... 4
- III. SAFETY GUIDELINES.....6
- IV. EMI & RFI INFORMATION.....13
- V. PARTS.....14
- VI. SETUP.....16
- VII. COMFORT ADJUSTMENTS.....19
- VIII. ASSEMBLY & DISASSEMBLY.....21
- IX. OPERATION.....24
- X. BATTERIES & CHARGING..... 25
- XI. INSPECTION & MAINTENANCE.....27
- XII. BASIC TROUBLESHOOTING.....31
- XIII. SPECIFICATIONS.....32
- XIV. LIMITED WARRANTY.....33
- XV. ACCESSORIES.....35

I. PREFACE

Please read this Owner's Manual before operating your scooter for the first time. Improper use or unfamiliarity of the scooter may result in harm, injury, or traffic accidents.

This Owner's Manual includes operation instructions, assembly instructions, and best practices to ensure maximum use from your scooter.

The symbols used throughout this Owner's Manual are explained below. Read carefully, and fully understand the sections marked with these symbols:

| | |
|--|--|
|  | WARNING – Improper use could lead to death, serious injury, hazardous conditions, or product malfunction. |
|  | ATTENTION – Improper use could lead to injury and/or damage to your scooter. |
|  | SUGGESTION – Follow these instructions for best practices, and to keep your scooter in prime operating order. |

This Owner's Manual includes a repair maintenance record chart and warranty. Please keep it in a safe place, or with the scooter.

If someone else uses the scooter, please provide a copy of the Owner's Manual for their consideration.

This Owner's Manual is composed from the product design and specifications at the time of publication. As designs change, some illustrations and pictures in the manual may not correspond to the scooter that you purchased. We reserve the right to make design modifications.

This product has been designed to provide a comfortable and secure solution for individuals limited to a seated position who are capable of operating a scooter.

The manufacturer disclaims all responsibilities for any personal injury or property damage which may occur as a result of improper or unsafe use of this product.

II. SAFETY NOTICES

- * Read and follow the information in the owner's manual.
- * Fully charge the battery after every trip and prior to using the scooter. If you do not frequently use the scooter fully charge the batteries every two weeks to prevent battery failure.
- * If the battery gauge drops to red, charge the scooter as soon as possible. Completely discharging the batteries may damage the batteries, or shorten the expected life of the batteries.
- * Batteries contain lead and lead compounds. Wear proper safety attire when handling batteries.
- * Only use sealed lead acid AGM or gel-cell batteries in this product.
- * Keep metal objects away from the battery terminals, electric shock may occur.
- * Always replace both batteries at the same time for optimum performance.
- * Always make sure the power is turned off when getting in and out of the scooter.
- * Always make sure freewheel levers are in the drive position before getting in or out of the scooter.
- * Do not put the scooter in freewheel when on an incline or decline.
- * To ensure the user's familiarity with the scooter's operation, practice driving at low speeds in a spacious hazard-free area travelling forward, backward, left, right, decelerating, maneuvering up inclines, and down inclines.
- * Avoid unnecessary movement of the scooter.
- * Never reach, lean or bend when driving your scooter.

II. SAFETY NOTICES

- * Avoid exposure to moisture, standing water, rain, snow, ice or salt when possible.
- * Store in a clean and dry condition.
- * Do not drive your scooter at night without proper lighting.
- * Do not remove the anti-tip wheels.
- * Keep your feet on the foot board at all times during operation.
- * Do not stand on the foot board.
- * Keep your hands and feet away from moving parts while driving.
- * Be aware of loose fitting clothes that can become caught in the drive wheels.
- * Do not connect an extension cord to the battery charger.
- * Disassembling the controller, motor, or charger by anyone other than an authorized Drive Medical service agent is prohibited, and voids any applicable warranty.
- * Do not take your scooter on roads or highways.
- * Do not operate your scooter when you are tired, or after consuming alcohol.
- * Be cautious when driving your scooter in busy areas or shopping malls.
- * Under no circumstances should the scooter be used as a seat in a motor vehicle.
- * Do not attempt to lift your scooter by any parts other than the frame.
- * If you will be seated in your scooter for an extended period of time, power off the scooter. This will prevent inadvertent movement from unexpected throttle contact.

III. SAFETY GUIDELINES

GENERAL GUIDELINES

Before operating your scooter fully read and understand this Owner's Manual.

Be sure to follow the setup instructions prior to using your scooter for the first time.

Users may encounter difficult maneuvering situations such as narrow doorways, travelling up and down ramps, cornering, and travelling on uneven terrain. Be sure to lower the speed, take your time, and carefully maneuver the scooter.

MODIFICATIONS

Do not modify, remove, disable, or add any parts, features, or functions on your scooter. Drive Medical offers a wide variety of accessories for your scooter to help accommodate your needs.



WARNING – Do not modify your scooter in any way; doing so will void the warranty.

SAFETY CHECK



ATTENTION – Inspect the following components before each use:

- * Electrical connections – secure and free from corrosion
- * Freewheel Levers – engaged in drive position
- * Batteries – fully charged and free from corrosion

If you notice a problem please contact your authorized Drive Medical Provider for assistance.

III. SAFETY GUIDELINES

WEIGHT CAPACITY

This scooter has a maximum weight capacity that should never be exceeded. Please refer to Section XII SPECIFICATIONS for this information. The maximum weight capacity includes the user and any accessories.



WARNING – Exceeding the maximum weight capacity will void your warranty. Drive Medical will not be held responsible for injuries and/or damages resulting from failure to observe weight capacities.



WARNING – Do not carry passengers on your scooter. Your scooter is designed and tested for one user to operate while seated.

INCLINE GUIDELINES

Use caution when approaching inclines or declines; if necessary lower the speed before travelling on a slope.

When travelling up an incline try to keep the scooter moving forward. If you must come to a stop, use caution and slowly accelerate the scooter forward.

When travelling down an incline lower the speed on your scooter to the slowest setting, and proceed cautiously. If the scooter is travelling down the incline faster than you expected, slowly release the throttle to come to a stop, then slightly push the throttle forward to continue safely down the incline.



WARNING – Never put the scooter in freewheel model while on an incline.



WARNING – Drive your scooter straight up or down an incline, never backwards. Erratic movements, or back and forth patterns may increase the chance of tipping.

III. SAFETY GUIDELINES



WARNING – Do not travel up an incline with the seat completely reclined without an attendant. Inclines vary, and doing so may decrease stability.



WARNING – Do not, under any circumstances, travel on a slope greater than the maximum climbing angle for this scooter. Please refer to Section XII SPECIFICATIONS for this information. Exceeding the climbing angle may cause unstable conditions.

FREEWHEEL GUIDELINES

Your scooter is equipped with manual freewheel levers to maneuver the unit without power. The manual freewheel levers can be engaged or disengaged.

Disengaged, or “freewheel” mode, releases the locking mechanism on the gearbox allowing the scooter to roll freely with or without power.

Engaged, or “drive” mode, secures the locking mechanism on the gearbox preventing the scooter from rolling freely.



WARNING – Never attempt to personally put your scooter in freewheel mode while seated in the unit.



WARNING – Never put the scooter in freewheel mode while on an incline. This may cause uncontrollable movements.



ATTENTION – When your scooter is in freewheel mode you may feel resistance when maneuvering; this is normal, and prevents damage to the gearbox.



ATTENTION – Please refer to Section V PARTS to locate the freewheel levers on your scooter.



SUGGESTION – If you hear a “clicking” noise when engaging the throttle, but the scooter will not move – turn off the power, engage the freewheel levers, and power back on to continue.

III. SAFETY GUIDELINES

BRAKES & STOPPING

Coming to a stop in your scooter can simply be done by releasing the throttle. The throttle will automatically return to the center position, and the scooter will come to a stop.



ATTENTION – Quickly moving the throttle in the opposite direction of travel will cause the scooter to come to an abrupt stop, and if held continuously in the opposite direction may cause erratic movements if you are unfamiliar with the controls.

Your scooter is equipped with two types of brake systems:

- * Regenerative brakes – when the throttle is returned to the center position, or stop neutral position, regenerative brakes use electricity to quickly decelerate the vehicle.
- * Park brakes – once the scooter comes to a complete stop the park brake activates automatically locking the drive wheels.

OUTDOOR OPERATION & INCLEMENT WEATHER PRECAUTIONS

While your scooter is purposed for in-home use to assist you in daily living activities; Drive Medical understands there are times you need to operate the scooter outdoors, and has designed it to perform superbly on level outdoor surfaces.



ATTENTION – When operating outdoors avoid uneven terrain, soft surfaces, tall grass, loose gravel, loose sand, fresh water, salt water, edges of streams, lakes or oceans. If you are unsure about a surface, avoid it.

Exposure to inclement weather should always be avoided. If you find yourself caught in inclement weather while operating your scooter, proceed to the closest shelter immediately. Completely dry your scooter before operating, charging, or storing.

III. SAFETY GUIDELINES

STEPS, CURBS & FIXED OBSTACLES

Use extreme caution when operating your scooter near curbs, porches, stairs, escalators, drop-offs, unprotected ledges, and raised areas.



WARNING – Never attempt to navigate your scooter over a fixed obstacle taller than the maximum ground clearance. Please refer to Section XII SPECIFICATIONS for this information.



WARNING – Never attempt to navigate your scooter backwards over an obstacle.



WARNING – Never attempt to operate your scooter on steps or escalators.



ATTENTION – Refer to the following guidelines and diagrams when travelling over a fixed obstacle lower than the maximum ground clearance of your scooter:

To maneuver up a fixed obstacle – Approach slowly, and make sure the front of the scooter is perpendicular to the obstacle. Increase the forward speed until the scooter has cleared the obstacle, and then you may reduce the speed or return the throttle to neutral.

To maneuver down a fixed obstacle – Approach slowly, and make sure the front of the scooter is perpendicular to the obstacle. Reduce the forward speed just before the front wheels come in contact with the obstacle, and remain at the reduced speed until scooter has cleared the obstacle, and then you may increase the forward speed.

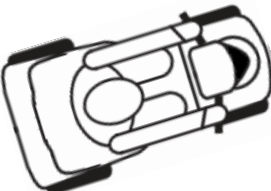
| | |
|--|--|
| <p>CORRECT APPROACH:</p>  <p>C U R B</p> | <p>INCORRECT APPROACH:</p>  <p>C U R B</p> |
|--|--|

III. SAFETY GUIDELINES

TRANSPORTING YOUR SCOOTER

When transporting your scooter by vehicle it should be securely stowed in the back of a van, truck, or trunk of a car. Adjustable parts should be removed or properly secured during transport.



WARNING – Do not sit in your scooter while in a moving vehicle.

POSITIONING BELT (OPTIONAL)

A safety belt may be included with your scooter. Your authorized Drive Medical Provider, assistive technology therapist, or healthcare professional are responsible for determining your requirement for a safety belt to operate your scooter safely. Once determined, securely fasten the safety belt.



WARNING – The safety belt is not designed for use as a seat belt in a motor vehicle, or any other transportation device.

TRANSFERS

Always have an attendant present while transferring in and out of your scooter.



ATTENTION – To reduce the possibility of an injury; perform transfers after the following steps are followed:

Safely reduce the distance between your scooter and the object you are transferring onto, ensure your scooter is not in freewheel mode, turn the power off, and flip up or remove the armrests.



WARNING – Position yourself as far back possible before transferring, and never place your weight or downward force on adjustable parts.

III. SAFETY GUIDELINES

PHYSICAL LIMITATIONS, Rx DRUGS, ALCOHOL & SMOKING

You must exercise awareness, caution, care, and common sense when operating your scooter. Always keep in mind your own limitations, and substance use when operating your scooter.



WARNING – Never use your scooter while under the influence of alcohol or mind altering substances.



WARNING – Never smoke while seated in your scooter. Damaged or worn upholstery increases the risk of fire hazard, and should be replaced immediately.



ATTENTION – Be aware of your own physical limitations when familiarizing yourself with the scooter.



ATTENTION – Be aware of precautions, warnings, and safety issues when taking prescribed or over-the-counter drugs while operating your scooter.

IV. EMI INFORMATION

Electromagnetic interference (EMI) tests have shown to produce adverse effects on the performance and control of electrically powered mobility devices.

EMI can be produced from different sources such as cellular phones, two-way radios, radio stations, television stations, amateur radio transmitters (HAM), wireless computer links, microwave signals, paging transmitters, and transceivers used by emergency vehicles.

The EMI waves can cause unintentional movement of the scooter, or damage to the controller. Every electrical powered mobility device has a resistance to EMI. The higher the resistance level the greater the protection. The intensity of the interference can be measured in volts per meter, V/m.

At this time, current technology is capable of achieving an immunity level of 20 V/m, which provides protection from more common sources of EMI. Your scooter, with no modifications, has an immunity level of 20 V/m.

EMI becomes more intense as you move closer to the source. The EMI produced from hand-held radios are of special concern. It is possible to unintentionally bring high levels of EMI very close to the scooter's control system, effecting your movement and braking. The warnings listed below are recommended to prevent possible interference with the control system of your scooter.



WARNING – Do not operate hand-held transceivers such as CB (citizens band) radios, or turn on personal communication devices, such as cellular phones, while the scooter is powered on.



WARNING – Be aware of nearby transmitters, such as radio or television stations, and avoid close proximity.



WARNING – If you experience unintended movement or brake release occurs, power off as soon as it is safe. Please report EMI incidents to Drive Medical.

V. PARTS

Please refer to the diagram below to identify your scooter parts. Familiarize yourself with the terminology to better understand part references throughout the Owner's Manual.

1. Headrest
2. Seat Back
3. Armrests
4. Seat Base
5. Control Panel
6. Basket
7. Tiller Adjustment Knob
8. Seat Swivel & Release Lever
9. Seat Post
10. Headlight
11. Footboard
12. Accessory Post
13. Freewheel Lever
14. Anti-tip Wheels



V. PARTS

Please refer to the diagram below to identify your scooter control panel and its functions. Familiarize yourself with the terminology to better understand references throughout the Owner's Manual.

1. Speed Dial
2. Headlight Switch
3. Hazard Light Switch
(DLX Only)
4. Battery Indicator
5. Indoor/Outdoor Switch
(DLX Only)
6. Horn Button
7. Turn Signal Switch
(DLX Only)
8. Throttle
9. Key Switch
10. Charge Port



VI. SETUP

Your scooter requires assembly prior to initial use. Please be sure to follow these steps to properly set up your scooter.

Step 1:

Loosen and remove the two shroud knobs by hand that secures the rear shroud to the base of the scooter. Lift up on the shroud to remove.

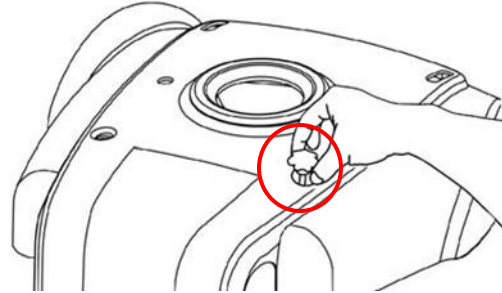

Step 2:

Connect the red battery connector to the main cable.

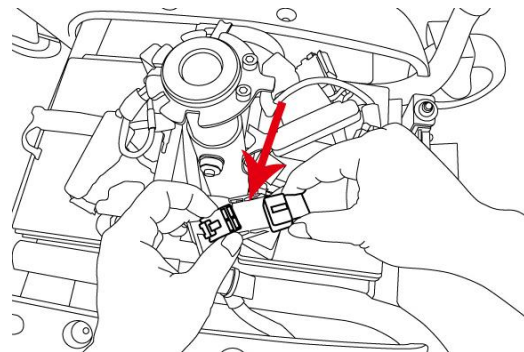

Step 3:

Reinstall the scooter's shroud by placing on top of the base, and reinstall the two shroud knobs removed in Step 1.

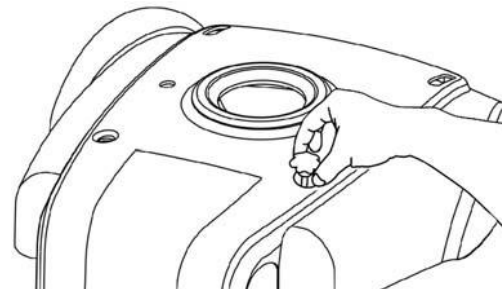

VI. SETUP

Step 4:

Attach the seat by lifting up on the handle underneath the seat, and placing the seat down on the seat post. Release the handle and rotate the seat side-to-side to ensure the seat is locked and facing forward.

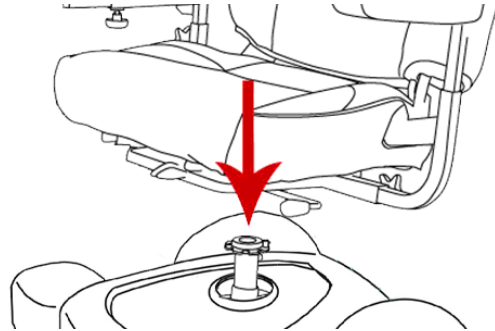

Step 5:

Insert the armrests into the attachment points in the seat frame so that the armrests face forward.

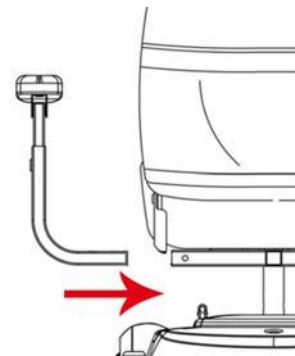

Step 6:

Tighten the star knobs to lock the armrests into place at the desired width.

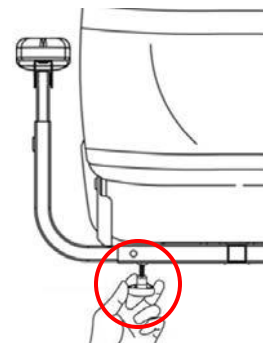

VI. SETUP

Step 7:
Affix the headrest to the top of the seat
by inserting the headrest posts into the
holes in the top of the seat back.
(DLX Only)

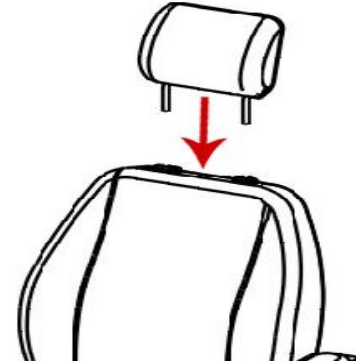

VII. COMFORT ADJUSTMENTS

Prior to using your scooter, you may want to make adjustments for optimum comfort. Make all adjustments with the scooter off, and unoccupied.



WARNING – Some components of your scooter are heavy, and you may need assistance to lift or carry. Please refer to Section XII SPECIFICATIONS for component weights.



WARNING – Do not make any adjustments while an occupant is seated in the scooter.

Seat Swivel Adjustment:

The seat can be rotated and locked in position at 45° intervals. Lift up on the handle under the left side of the seat and turn the seat to the desired position, releasing the handle to lock the seat in place.



WARNING – Return the seat to the forward position before driving.

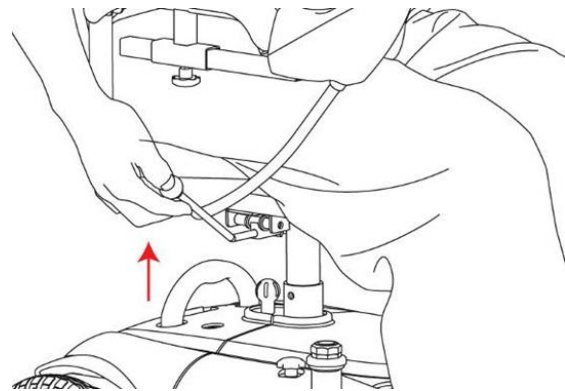

Seat Height Adjustment:

Remove the seat from your scooter, then remove the nut and bolt holding the seat post in place. Adjust the seat post to the desired height, and reinstall the nut and bolt removed. Be sure the nut and bolt are tightened securely to reduce vibrations, and improve stability.

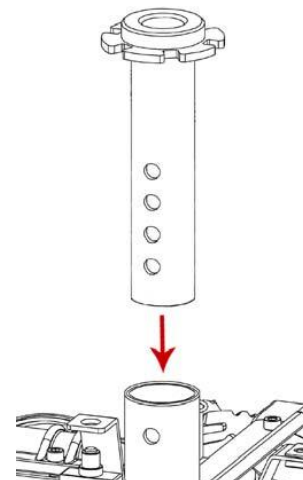

VII. COMFORT ADJUSTMENTS

Armrest Width:

The armrest width can be adjusted by loosening the star knob on the underside of the armrests, and sliding the armrests inward or outward to the desired width.

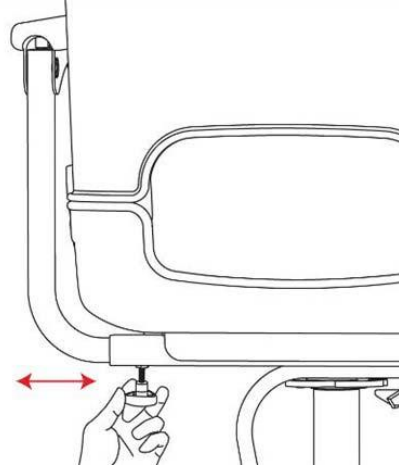

Armrest Angle:

The armrest angle can be adjusted by lifting up on the armrest, and tightening or loosening the bolt underneath the armrest. Tightening will lower the angle, and loosening will raise the angle of the armrest.

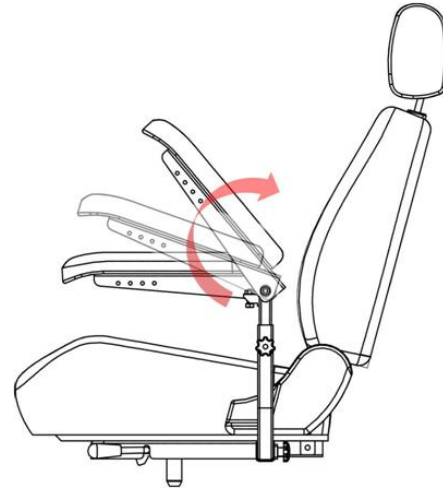

Armrest Height:

The armrest height can be adjusted by loosening the star knob on the top side of the armrest, and sliding the armrests up or down to the desired height.

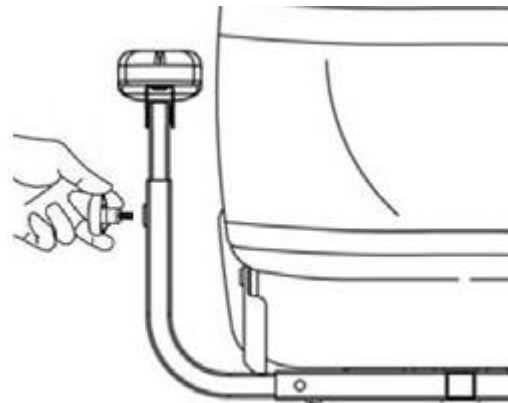

VIII. ASSEMBLY & DISASSEMBLY

Your transport scooter can be disassembled into five sections without tools: the seat, basket, battery pack, front section and rear section. Please be sure to follow these steps to properly assemble and disassemble your scooter.

Disassembly:

Step 1:

Pull up on the swivel release lever to remove the seat from the post.



Step 2:

Loosen and remove the two shroud knobs by hand that secures the rear shroud to the base of the scooter. Lift up on the shroud to remove.

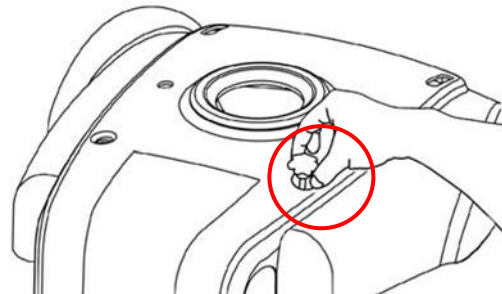

Step 3:

Disconnect the battery harness, and blue electrical harness. Remove the batteries and set aside.



VIII. ASSEMBLY & DISASSEMBLY

Step 4:
Pull up on the handle to split the front and rear section of the base.



Assembly:

Step 1:
Line up the front and rear sections of the base. Lift up on the connecting handle, and slowly lower the front and rear sections until the two lock together.

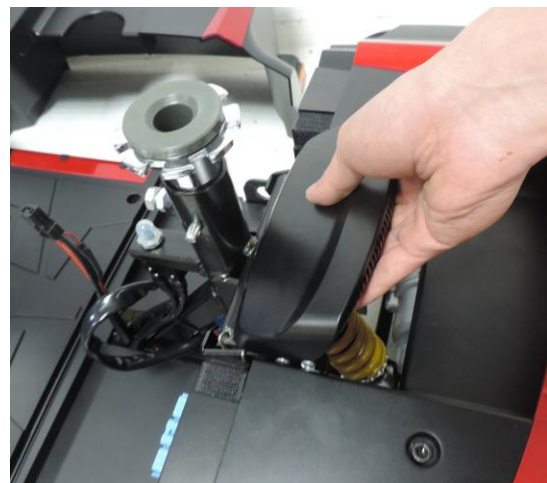

VIII. ASSEMBLY & DISASSEMBLY

Step 2:

Place the batteries onto the scooter, and reconnect the battery harnesses and blue electrical harness.



Step 3:

Reinstall the scooter's shroud by placing on top of the base, and reinstall the two shroud knobs.

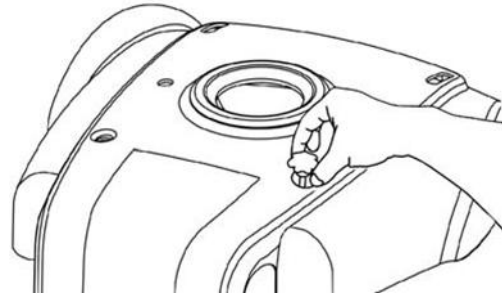

Step 4:

While lifting up on the seat release lever, place the seat onto the seat post. Release the lever and rotate the seat until it locks into place.

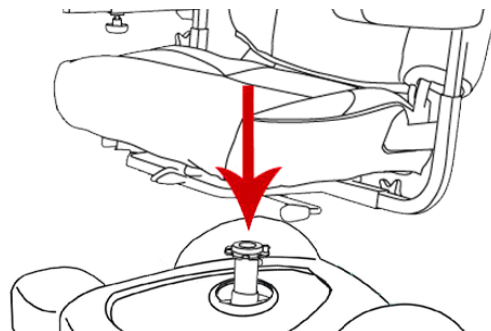

IX. OPERATION

After your scooter is assembled, and adjustments have been made you are now ready to operate your scooter. Refer to the tiller diagram in Section V PARTS for key functions.

The key switch applies power to the control system electronics, which in turn supplies power to the motors. Turn the key switch with the key inserted to turn on your scooter.



ATTENTION – Do not use the key switch to stop, or as a brake. Doing so may shorten the life of the drive components.



SUGGESTION – It is recommended you start at the slowest speed setting when familiarizing yourself with your scooter controls. Once you feel comfortable with the controls, and movement of the scooter you may then increase the speed.

Rotate the speed knob to the lowest speed setting. Engage the throttle, and begin steering to drive forward, backward, left or right. If you want to stop the scooter, release the throttle and it will automatically return to the center position to stop the unit. Once familiar with the controls rotate the speed knob to increase the top speed to a comfortable setting.

When the scooter is turned on, the battery gauge will display red, orange, and green indicators:

Red: Your scooter should be charged as soon as possible.

Orange: Do not drive your scooter for a long trip.

Green: Your scooter has full battery capacity.

X. BATTERIES & CHARGING

CHARGING YOUR SCOOTER

To charge your scooter, position the front of the unit next to a standard electrical outlet. Be certain the freewheel levers are engaged, and the power is turned off. Plug the charger into the scooter, and then into the electrical outlet. When the batteries are fully charged remove the charger from the scooter.



SUGGESTION – The lights on your charger indicate different charge statuses. The light indicators can be found on the charger itself, or the manual provided with the charger. In most cases your charger will show a red or orange light when charging, and a green light when fully charged.

BATTERY BREAK-IN

To ensure maximum use from your new batteries fully charge the scooter prior to initial use for 8 to 12 hours. Operate your scooter until the battery gauge shows half capacity, and then give your scooter another full charge for 8 to 12 hours.

BATTERY MAINTENANCE & CHARGING HABITS

To ensure maximum life from your batteries, and continued use of your scooter please follow these charging guidelines based on your usage:



SUGGESTION – If you use your scooter on a daily basis, charge the batteries as soon as you are finished with the day's activities, and leave it on the charge until you are ready to use the following day.



SUGGESTION – If you use your scooter infrequently, charge the batteries once a week for 10 to 14 hours.

X. BATTERIES & CHARGING

BATTERY RANGE

There are many factors that affect the range of your batteries, including the surfaces, inclines, curves, or wind you encounter when operating your scooter. If not ideal conditions, all of these factors will reduce the travel time or distance between charges. Follow these suggestions for maximum range:



SUGGESTION – Fully charge the batteries prior to any trip, and plan your trip in advance to avoid inclines.



SUGGESTION – Limit baggage and accessory weight to essential items, and maintain an even speed avoiding stop-and-go driving.

PUBLIC TRANSPORTATION

Sealed lead acid AGM or gel-cell batteries are designed for use in scooters. These batteries are Federal Aviation Administration (FAA) approved. Since there is no danger of spillage or leakage, this allows for safe transportation on aircraft, buses, and trains.



SUGGESTION – When transporting your scooter on public transportation contact your carrier's ticket counter in advance to determine their specific requirements.

XI. INSPECTION & MAINTENANCE

GENERAL GUIDELINES

Your scooter is an advanced mobility device, and with the correct routine maintenance you can ensure years of maximum use. While some of the maintenance can be done by yourself, you may need assistance from an authorized Drive Medical provider. If you have any doubts, contact your authorized Drive Medical provider.

Preventative maintenance is key to keeping your scooter in prime operating condition. Follow the Maintenance Schedule at the end of this section to periodically inspect your scooter for serviceable items.

- * Avoid abuse to the throttle and control functions.
- * Avoid prolonged exposure to extreme heat or cold.
- * Keep the scooter clean and free from moisture.
- * Never use a conditioner on the tread of the wheels.

EXPOSURE TO MOISTURE

Should your scooter come in contact with water or moisture, dry your scooter thoroughly with a towel. Allow your scooter to sit in a dry place for 8 to 12 hours to allow unseen moisture to evaporate. Check the throttle operation and brakes before using your scooter again. If any items require service please contact your authorized Drive Medical provider.

OPERATING TEMPERATURES

Your scooter is designed to operate ideally between 18°F and 122°F. In extremely cold conditions your batteries may freeze depending on the battery charge, usage, and composition of the batteries. In extremely hot conditions your scooter may operate at a lower speed. This is due to the safety mechanism built into the unit to prevent damage to the gearbox and other electronic functions when operating too hot.

XI. INSPECTION & MAINTENANCE

STORAGE

If you need to store your scooter, be sure it is stored in a dry place free from extreme temperatures. Always fully charge, and then disconnect the batteries prior to storage.



ATTENTION – Infrequently charged batteries, or batteries stored without a full charge are susceptible to permanent damage, causing unreliable performance from your scooter.

If your scooter is stored for a prolonged period flat spots may develop in the wheels. This will cause an uneven sensation when driving, but should work itself out over time. If you still notice the flat spots after continued use, replace the wheels on your scooter immediately.



SUGGESTION – You can place a sturdy platform under the frame of your scooter to bring the wheels off the ground, and weight off the wheels. This will prevent flat spots from developing while storing your scooter.



WARNING – Improper storage of your scooter may result in permanent damage to the frame and electronics.

CLEANING & DISINFECTION

To clean your scooter use a damp cloth with a mild, non-abrasive cleaner on the plastic and metal parts. If necessary, clean your scooter with an approved disinfectant safe for use on your unit.



WARNING – Never hose off your scooter or expose it to direct contact with water.



WARNING – Never use any chemicals on the upholstery of your seat, this may cause the seat to dry out and crack.

XI. INSPECTION & MAINTENANCE

DISPOSAL OF YOUR SCOOTER & PARTS

You must follow applicable local and national regulations when disposing of your scooter, or defective scooter parts. Contact your local waste agency, recycling center, or authorized Drive Medical provider for information on proper disposal.

CONTACTING YOUR AUTHORIZED DRIVE MEDICAL PROVIDER

The following conditions may indicate a serious problem with your scooter. Contact your authorized Drive Medical provider if one of the following conditions occurs:

- * Motor or gearbox noise
- * Frayed electrical harnesses
- * Cracked or broken connections
- * Uneven wear on the tires
- * Veering to one side
- * Bent or broken wheel assemblies
- * Will not power on
- * Loose seat or seat components



SUGGESTION – Fill out your authorized Drive Medical provider’s information below, along with your scooter information for quick reference in the event you may need service.

AUTHORIZED DRIVE MEDICAL PROVIDER: _____
ADDRESS: _____
PHONE NUMBER: _____
DATE OF PURCHASE: _____
MODEL: _____
SERIAL NUMBER: _____

XI. INSPECTION & MAINTENANCE

MAINTENANCE SCHEDULE

Inspect your scooter routinely for service issue or wearable items.

| INSPECTION | DAILY | WEEKLY | MONTHLY |
|---|-------------------------------------|-------------------------------------|-------------------------------------|
| Inspect the throttle is not bent when in neutral or rest position | <input checked="" type="checkbox"/> | | |
| Inspect electrical harnesses are not frayed or have exposed wires | <input checked="" type="checkbox"/> | | |
| Check for flat spots on tires | <input checked="" type="checkbox"/> | | |
| Inspect seat, armrests, and front riggings for loose hardware or damage | <input checked="" type="checkbox"/> | | |
| Inspect batteries are free from corrosion | | <input checked="" type="checkbox"/> | |
| Inspect all harnesses to the controller are securely fastened | | <input checked="" type="checkbox"/> | |
| Check the brakes for functionality at lowest speed setting | | <input checked="" type="checkbox"/> | |
| Check the anti-tip wheels for wear, and contact with the ground while at rest | | | <input checked="" type="checkbox"/> |
| Check for sufficient tread on the tires | | | <input checked="" type="checkbox"/> |
| Check for proper tire inflation, if applicable to your scooter | | | <input checked="" type="checkbox"/> |
| Check for proper front wheel alignment (4-wheel scooters only) | | | <input checked="" type="checkbox"/> |
| Check the entire scooter for loose hardware or changes in performance | | | <input checked="" type="checkbox"/> |
| Check the entire scooter and clean any mud, dirt, hair, food, drink, etc. on the unit | | | <input checked="" type="checkbox"/> |



SUGGESTION – Once a year take your scooter to an authorized Drive Medical provider for inspection and maintenance.

XII. BASIC TROUBLESHOOTING

The diagnostic flash codes for your scooter are designed to help you perform basic troubleshooting quickly and easily. A diagnostic flash code is displayed by:

- * The battery indicator light farthest to the left on the battery gauge (red light) will flash a 2 digit fault.

Please refer to the diagram below for flash codes, description of problem, and recommended actions.

| Flash Code | Description | Recommended Action |
|------------|------------------|--|
| 1 | Low Battery | Recharge battery |
| 2 | Motor Fault | Check the motor connections, wiring and brushes |
| 3 | Wiring Fault | Check the connections/wiring between the motor and batteries |
| 4 | Brake Fault | Check the brake connections and wiring |
| 5 | Not Used | N/A |
| 6 | Charger Fault | Disconnect the charger from the scooter |
| 7 | Throttle Fault | Make sure the throttle is not engaged when turning on the scooter |
| 8 | Controller Fault | Check the controller connections and wiring |
| 9 | Brake Fault | Check the brake connections and wiring |
| 10 | High Voltage | If driving downhill slow down and turn lights on. Test the charger to ensure that it cuts off when batteries are full charged. |

Once the recommended action is taken, turn the scooter off and then back on again to clear the flash code. If the problem was not corrected, or another problem exists the controller may display another flash code.



ATTENTION – Your scooter may have a diagnostic light on the tiller that will stay on constantly. The light will begin to flash when you have a serviceable item.

XIII. SPECIFICATIONS

| | |
|------------------------------|--|
| WEIGHT CAPACITY | 400 lbs. |
| TOP SPEED* | 6 mph |
| ESTIMATED RANGE* | 22 miles |
| MAX. CLIMBING ANGLE | 7.5° |
| TURNING RADIUS | 53" (3-Wheel) 54" (4-Wheel) |
| GROUND CLEARANCE | 2.5" |
| OVERALL DIMENSIONS | |
| LENGTH | 48" |
| WIDTH | 25" |
| HEIGHT | 45" |
| SEAT DIMENSIONS | |
| WIDTH | 18" (Folding & Captain) 20" (Captain) |
| DEPTH | 17.5" (Folding) 18" (Captain) |
| BACK HEIGHT | 15" (Folding) 18" (Captain) |
| POWER | |
| MOTOR | 24V x 350W x 5100 rpm |
| CONTROLLER | PG S Drive 70A |
| BATTERIES | 12V x 33AH |
| BATTERY CHARGER | 4A Offboard |
| BRAKES | Electromagnetic |
| FREEWHEEL MODE | Yes |
| FRONT WHEELS | 10" x 3" Flat-Free |
| REAR WHEELS | 10" x 3" Flat-Free |
| ANTI-TIP WHEELS | 2.5" |
| WEIGHTS | |
| BASE WEIGHT | 88 lbs. (3-Wheel) 99 lbs. (4-Wheel) |
| BATTERY WEIGHT (PAIR) | 44 lbs. |
| SEAT WEIGHT | 26 lbs. (Folding) 55 lbs. (Captain) |
| HEAVIEST PIECE WEIGHT | 60 lbs. (3-Wheel) 70 lbs. (4-Wheel) |
| TOTAL WEIGHT | 158 lbs. / 187 lbs. (3-Wheel) 169 lbs. / 198 lbs. (4-Wheel) |

* Speed and range vary with user weight, type of terrain, battery charge and condition

The information contained herein is correct at the time of publication; Drive Medical reserves the right to alter specifications without prior notice.

XIV. LIMITED WARRANTY

For the warranty periods listed below, beginning at the date of original purchase, Drive Medical will repair or replace, at its option to the original purchaser, free of charge, any of the following parts found upon examination by an authorized representative of Drive Medical to be defective in materials and/or workmanship. The warranties contained herein extend and apply only to the original purchaser.

- | | | | | |
|-------------------------|---|--|----------------------------------|--|
| Limited Lifetime | ○ Main Frame | ○ Seat Post | ○ Platform | ○ Frame Welds |
| 14 Months | ○ Electrical harness ○ Controller ○ Charger | ○ Joystick ○ PC Board ○ Throttle | ○ Motor / gearbox assembly | ○ Brakes electromagnetic function ONLY |
| 6 Months | ○ Batteries are covered by a separate 6 month warranty provided by the battery manufacturer | | | |

The following items are warranted to be free of defects in workmanship and material at the time of delivery. If the following items are found to be defective or damaged immediately after the product is removed from the box, Drive Medical will repair or replace, at its option to the original purchaser, free of charge, the following items:

- | | | | |
|---|-------------------------|-----------------------------------|--------------------------------------|
| ○ Plastic shrouds | ○ Tires | ○ Tubes | ○ Anti-tip wheels |
| ○ Plastic footrests | ○ Floor mats | ○ Swing arm | ○ Motor brushes |
| ○ Upholstery and Seating | ○ Armrest pads | ○ Fuses and Bulbs | ○ Plastic connections |
| ○ Metal connection pins, hardware, nuts, bolts & star knobs | ○ Bearings and bushings | ○ Front rigging mounting brackets | ○ Plastic components, excluding body |

ADDITIONAL COMPONENTS

Items not mentioned or listed are covered at the discretion of Drive Medical. Any accessories, standard or optional, supplied by Drive Medical, are covered for a period of one year from the date of purchase with the particular unit.

XIV. LIMITED WARRANTY

RECONDITIONED UNITS WARRANTY

All reconditioned units are covered by a 90-day warranty from Drive Medical effective from the date of purchase.

REPLACEMENT PARTS WARRANTY

Parts that are supplied by Drive Medical as replacements to warranted parts will be warranted for a period of time equal to the remainder of the original part's warranty period.

SERVICE CHECKS AND WARRANTY SERVICE

Warranty service must be performed by an authorized Drive Medical provider. Do not return faulty parts to Drive Medical without prior written authorization. All transportation costs and shipping damage incurred while submitting parts for repair or replacement are the responsibility of Drive Medical.

Failure to follow the instructions, warnings and notes in the owner's manual and those located on your Drive Medical product can result in personal injury or product damage and will void Drive Medical's product warranty.

There is no other express warranty.

IMPLIED WARRANTIES

Implied warranties, including those of merchantability and fitness for a particular purpose, are limited to one (1) year from the date of original purchase and to the extent permitted by law. Any and all other

implied warranties are excluded. This is the exclusive remedy. Liabilities for incidental, punitive, special and consequential damages under any and all warranties are excluded.

Some states do not allow limitations on how long an implied warranty lasts or do not allow the exclusion or limitation of incidental, punitive, special and consequential damages. The above limitation or exclusion may not apply to you.

This warranty gives you specific rights and you may also have other rights which vary from state to state.

WARRANTY EXCLUSIONS

- Plastic shrouds and footrests
- Upholstery and seating
- Tires and tubes
- Brake pads
- Fuses
- Motor brushes
- Circumstances beyond the control of Drive Medical
- Labor, service calls, shipping and other charges incurred for repair of the product, unless specifically authorized by Drive Medical.
- Repairs and/or modifications made to any part without specific consent from Drive Medical.

XV. ACCESSORIES

Add functionality and convenience to your Drive scooter with these options and accessories. Contact your authorized Drive Medical provider or visit www.drivemedical.com for more information.

Dust Cover
Part#: AZ1000



- Protect your scooter from dirt and the elements with a cover fitted to your product's size

Trailer
Part#: AT1000



- Provides convenient transportation for your large items
- Removable cover protects your cargo
- Durable soft-sides and tough aluminum frame allow for easy storage

Oxygen Tank Holder
Part#: AH2000



- For use with "D" size oxygen cylinders
- Constructed of durable steel
- Keeps tank secure with helpful hook-and-loop fasteners

Crutch/Cane Holder
Part#: AH1000



- Sturdy steel construction
- Includes hook-and-loop-fasteners to keep your walking aid safely in place

Drink Holder
Part#: AZ0060



- Take your favorite hot or cold beverage with you anywhere
- Easily attaches to your product's armrest

Rear Basket
Part#: AB2100



- Roomy rear basket for additional storage
- Strong steel construction allows you to carry items too large or too heavy for your front basket

Armrest Bag
Part#: AB1010



- Includes four pockets and mesh drink holder
- Top of the bag is padded so resting your arm on it is even more comfortable

Backpack
Part#: AB1120



- Great seat-back storage for your items
- Super-sized, expandable main compartment with hook and loop fasteners
- 2 zippered compartments and 2 mesh side pockets



Drive Medical Design & Manufacturing

99 Seaview Boulevard

Port Washington, NY

Tel: (516) 998-4600

Fax: (516) 566-2043

www.drivemedical.com