

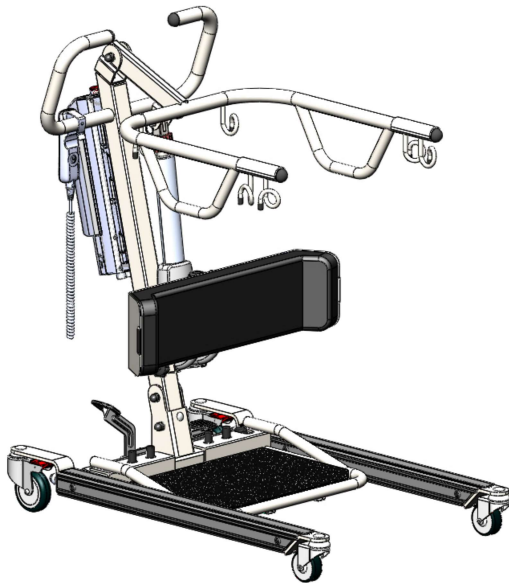

PROTEKT® 600 STAND
SIT-TO-STAND PATIENT LIFT
MODEL: 34600



OWNER'S MANUAL

270 Washington Street
Mount Vernon, NY 10553
855-237-7622
www.proactivemedical.com

Thank you for choosing the **Protekt® 600 Stand!**

To better serve you, please record the following information:

Supplier Name: _____

Telephone: _____

Serial #: _____

Date of Purchase : _____

INSPECT YOUR MERCHANDISE

Upon receipt of your patient lift, verify that all merchandise is complete and free from any shipping damage. Refuse delivery if the packaging appears to be badly damaged. If the merchandise is received damaged or is missing components, contact the shipping company immediately and file a claim.

For further assistance, contact your local dealer or Proactive Medical Products at the following:

Proactive Medical Products
270 Washington Street
Mount Vernon, NY 10553
Tel: 855-237-7622
www.proactivemedical.com

IMPORTANT NOTES!

Please pay attention to the important information regarding the care, maintenance, and operation of the Protekt® 600 Stand Sit-To-Stand Patient Lift 34600 in this manual.

Please read the instructions carefully before assembling the lift, or attempting to lift any patient with the device.

Always keep the Owner's Manual available with the lift.

WARNING!

Do not attempt to transfer a patient without prior approval of the patient's nurse or caregiver. Also, do not transfer without having studied the instructions and performed several practices in operating the product. Together (with the patient's doctor, nurse, or medical attendant) select a Proactive Medical Product sling that is both practical and comfortable. The sling selected should be one that serves the needs of the patient, while providing the patient with optimal safety. Never interfere with the lift, unless instructed by the attendant. Have a doctor, nurse, or medical attendant (experienced in the use of the Protekt® 600 Stand lift) present during the first few times the lift is used to transfer a new user.

SAFETY PRECAUTIONS

The Protekt® 600 Stand lift allows a caregiver to lift and transfer a patient safely with minimum physical effort. Before attempting to lift anyone, one should practice operating the lift and explain to the patient the lifting procedures.

Arrange all necessary items (e.g. lift, sling, commode chair or wheelchair) properly for a smooth procedure.

- Special care must be taken with patients who cannot provide assistance while being lifted. (i.e. patients who are comatose, spastic, agitated or otherwise severely handicapped).
- The Protekt® 600 Stand should be used solely for transferring a patient from one object (beds, bathtubs, toilets, etc.) to another. The lift should not be used for transporting or moving any patient from one location to another location.
- During lifting or lowering, whenever possible, always keep lift base widened.
- Always keep the patient being lifted centered over the base and facing the caregiver operating the lifter.
- Do not roll casters over any object while the user is in the sling.
- Proactive Medical slings are specially designed to be used in conjunction with Proactive lifts. Do not use slings manufactured by other companies on the lift. Proactive Medical is not responsible for any consequence resulting from the use of non-Proactive slings on this equipment.
- Do not put anything (e.g. cushion, pad, etc.....) between the user and the sling. This may cause user to slide out of the sling and cause injury.
- Use only genuine Proactive Medical parts or components. Proactive Medical is not responsible for any consequence resulting from using non-Proactive parts and components.
- Service and repair of this equipment should be performed only by an authorized dealer. Proactive Medical is not responsible for any consequence resulting from any unauthorized service or repair.
- Do not lift over the Maximum Weight limit of 600 lbs.

FEATURES CHART:

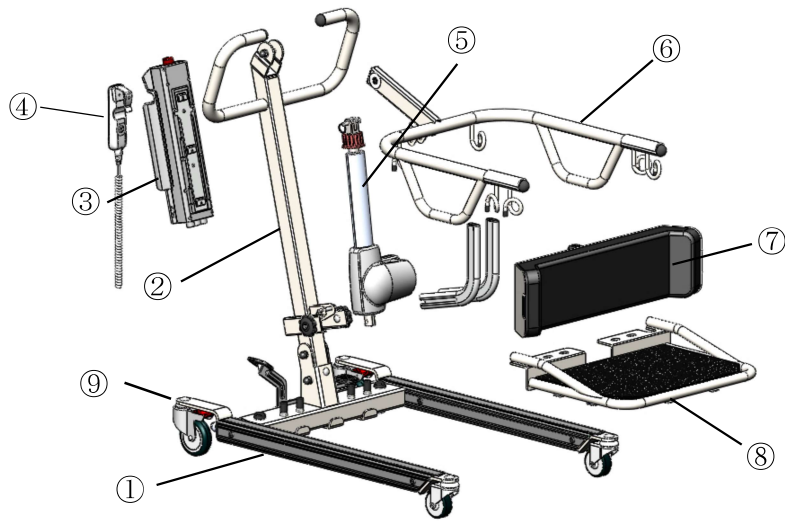

- ① Base
- ② Mast
- ③ Control Box
- ④ Pendant
- ⑤ Actuator
- ⑥ Lifting Boom
- ⑦ Kneepad Assembly
- ⑧ Footrest
- ⑨ Brake

ASSEMBLY INSTRUCTIONS:

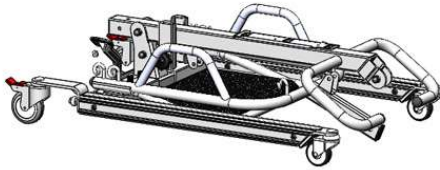

1. Open the box and take lift out.



2. Unscrew nuts and bolts at top and bottom of the mast.

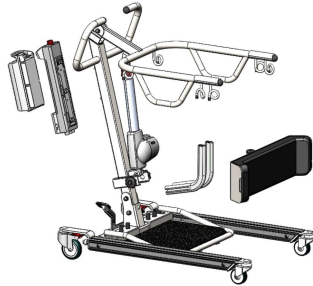

3. Attach boom to mast and hand tight bolt and nut.
4. Attach the L-shaped arms to back of the kneepad.
(For desired height of the kneepad, use proper holes on the L-shaped arms).
5. Attach kneepad assembly to the mast.
6. Attach actuator and pendant to the control box.

STEP 1:

Attach the L-shaped arms to the mast.

Make adjustment to the desired position.

STEP 2:

Use the bolt to fasten the L-shaped arms to the Mast.

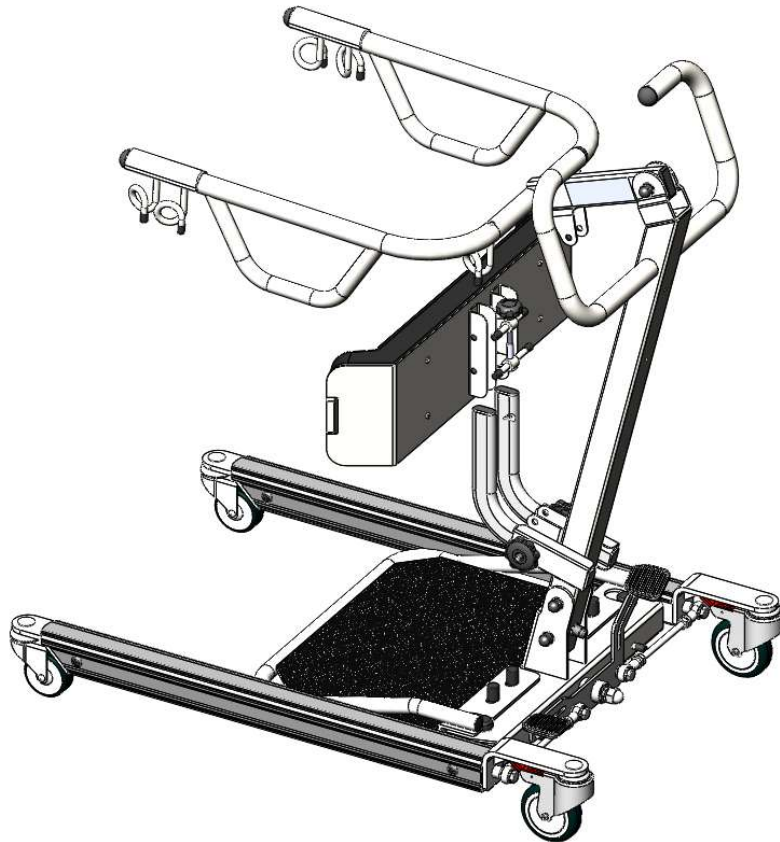

OPERATION INSTRUCTIONS:

Preparation Before Lifting

1. Turn on the power by twisting the RED RESET BUTTON clockwise.
2. Press the UP or DOWN button on the hand control once. Check if the battery indicator lights are on. To proceed with lifting, make sure there is at least one green light. Batteries are fully charged when three (3) green lights are shown.
3. After the battery indicator lights go out, push the UP button and the DOWN button on the hand control and ensure that the lift is operating correctly.
4. Position of the base of lift around or under the object.
5. Widen the base and engage the caster brakes.

Fitting Stand Assist Sling

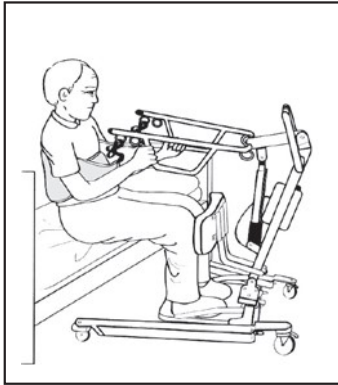

Safety Note: The Stand Assist sling is not suitable for patients who have involuntary movements, or patients with limited postural control.

1. Position the patient in a sitting position.
2. Slide the sling down patient's back to lumbar position.
3. Draw the shoulder straps to the front of the patient close to the chest.
4. Draw the waist belt around patient's waist and press together to fasten.
5. Attach the shoulder straps to the hooks.

Lift and Transfer From Bed



1. Fit sling as described in "Fitting Stand Assist Sling".
2. Push lift towards patient. Open the base of the lift. Apply the brakes in both rear casters.
3. Position patient's feet on the foot platform and knees against the knee pad.
4. Attached the sling straps to the hooks.
5. Have the patient's hands holding the handles. For patient's who cannot hold the handles, have them hold their arms around the chest.



6. Press the "UP" button on the hand control.
7. Before the patient's body is lifted from the bed, stop and make sure the sling is secured and patient's knees are against the knee pad.
8. The patient should be comfortable with the pressure under the arms. If not, adjust the sling and try another loop option to release pressure.
9. Press the "UP" button until the patient's body has completely left the bed.
10. Transfer to another object can be done at this position without the patient attending a full standing position.
11. Release the brakes, close the base, and pull the lift away from the bed.
12. Lower the patient to the object intended.



13. To lift patient in a standing position, continue to lift until the patient's knees are locked in a standing position.
14. At the standing position, patient's knees may move away from the knee pad.
15. Release the brakes, close the base, and pull the lift away from the bed.
16. Lower the patient to the object intended.
17. Reverse the above procedures when lowering the patient to the bed.

Lift and Transfer From Wheelchair

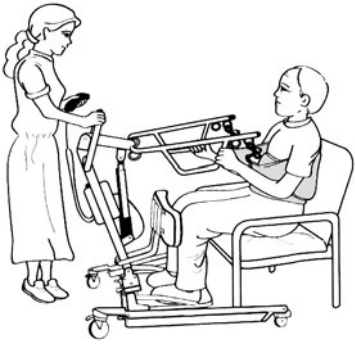

1. Fit sling as described in "Fitting Stand Assist Sling".
2. Push lift towards patient. Open the base of the lift to go around the chair. Apply the brakes in both rear casters.
3. Position patient's feet on the foot platform and knees against the knee pad.
4. Attached the sling straps to the hooks.
5. Have the patient's hands holding the handles. For patients who cannot hold the handles, have them hold their arms around the chest.



6. Press the "UP" button on the hand control.
7. Before the patient's body is lifted from the chair, stop and make sure the sling is secured and patient's knees are against the knee pad.
8. The patient should be comfortable with the pressure under the arms. If not, adjust the sling and try another loop option to release pressure.
9. Press the "UP" button until the patient's body is completely left the chair.
10. Transfer to another object can be done at this position without the patient attending a full standing position.
11. Release the brakes, close the base, and pull the lift away from the bed.
12. Lower the patient to the object intended.



13. To lift patient in a standing position, continue to lift until the patient's knees are locked in a standing position.
14. At the standing position, patient's knees may move away from the knee pad.
15. Release the brakes, close the base, and pull the lift away from the bed.
16. Lower the patient to the object intended.
17. Reverse the above procedures when lowering the patient to the bed.

USER GUIDE

CHARGING THE BATTERY -

The lift can be charged by plugging the charger directly into the control box while it is attached to the lift.

Or

The battery pack can be charged while seated in the optional wall/desk charging caddy.

OPERATING INSTRUCTIONS — USING THE CONTROL BOX



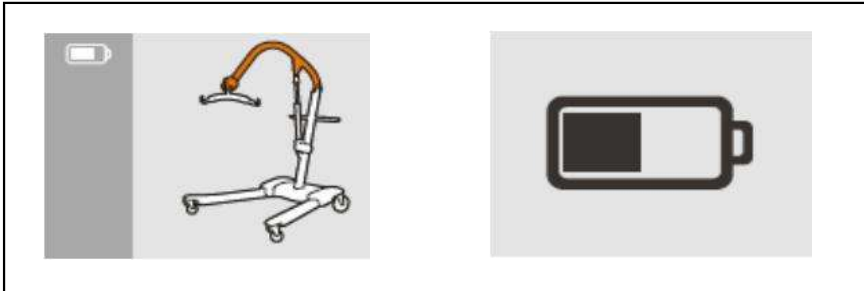
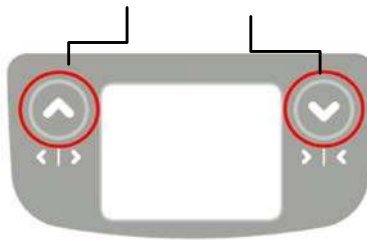

1. If you press either control button (shown at right) for less than 0.5 seconds, you can access the screens shown below.

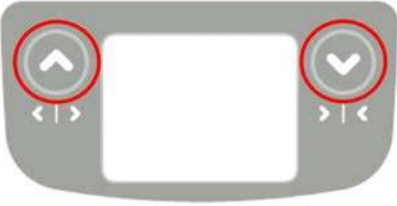

Control Buttons

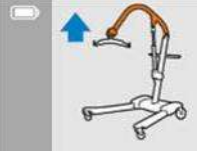

2.





<p>L Left button</p> <p>Pressing the left button for more than 0.5 seconds will begin actuator extension.</p>		<p>R Right button</p> <p>Pressing the right button for more than 0.5 seconds will begin actuator retraction.</p>
--	---	---

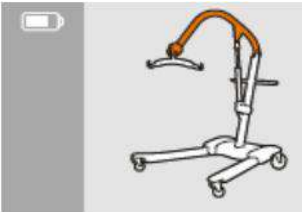

<p>Raise / Lower Lift</p> 	<p>Long press to raise lift </p> <p>Long press to lower lift </p>	 
---	---	---

3. Press the  button to raise or the  button to lower the lift.

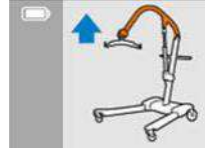
OPERATING INSTRUCTIONS — USING THE HAND PENDANT



Raise / Lower Lift	
	Long press to raise lift 
	Long press to lower lift 
	 

1. Press the  button to raise or the  button to lower the lift.

Sit to Stand/Transfer Slings

ITEM #	DESCRIPTION
30129 <i>Medium</i>	Sit to stand sling - solid: medium 440 lb. weight capacity
30130 <i>Large</i>	Sit to stand sling - solid: large 440 lb. weight capacity
30131 <i>X-Large</i>	Sit to stand sling - solid: X-large 440 lb. weight capacity
30139 <i>XX-Large</i>	Sit to stand sling - solid: XX-large 600 lb. weight capacity
30134 <i>Large</i>	Transfer sling - solid: large 350 lb. weight capacity
30136 <i>X-Large</i>	Transfer sling - solid: X-large 440 lb. weight capacity
30669B	Buttocks Support Strap 600 lb. weight capacity
31230	Knee Strap Brace

REPLACEMENT PARTS

LP-34600-FP	Replacement Foot Platform f/ Protekt Stand 34600
LP-34600-HPK	Replacement Hardware Pack f/ Protekt 34600 Lift
LP-34600-KP	Replacement Knee Pad f/ Protekt Stand 34600
LP-34600-TA12-ACT	Replacement Actuator f/ Protekt Stand 34600 (600lb Cap.)
LP-FC	Replacement Front Caster f/ Protekt Lift/Stand
LP-RC	Replacement Rear Locking Caster f/ Protekt Lift/Stand
LP-TBC2-CRDL	Battery Charger Cradle ONLY (no plug) f/ Protekt Lift/Stand
LP-TBC2-CRDL-PK	Battery Charger Cradle Pack (includes plug) f/ Protekt Lift/Stand
LP-TC12-BPAK	Replacement Battery Pack f/ Protekt Lift/Stand
LP-TC12-CBOX	Replacement Control Box f/ Protekt Lift/Stand
LP-TMH3-PEN	Replacement Hand Pendant f/ Protekt Lift/Stand
LP-TP7C-ADP	Replacement Plug f/ Protekt Lift/Stand

MAINTENANCE AND INSPECTION INSTRUCTIONS

- The operator of the lift shall inspect the lift before each use. Check all bolts for tightness. Make sure the base can be easily widened, and that all lift parts are in place. Make sure that casters can be turned freely, and that caster brakes can be engaged. Make certain all necessary items (i.e. slings, and wheelchairs, etc.) are ready for use.
- At least once a month, the lift should be thoroughly inspected by a person qualified to recognize any signs of wear and tear, and looseness of bolts or parts. Replace any worn parts immediately.
- To lubricate, put a drop of oil on the following points when the lift is placed into service and every month thereafter. Top of Mast, Spreader Hinge, and Casters.

Table of Maintenance Schedule:

Item	In the Beginning	Monthly	Every 3 Month
1. Boom & Spreader Bar : <ul style="list-style-type: none"> • Check connections between 1) Boom and Spreader Bar 2) Boom and Mast for improper connection, looseness, or wear. • Check the Boom for bending and deflection. 	•	•	
2. The Mast : <ul style="list-style-type: none"> • Check Mast for bending or deflection. 	•	•	
3. The Base & Foot Peddle : <ul style="list-style-type: none"> • Check bolts and nuts for looseness. • Check casters and bolts for tightness. • Check rubber parts of the casters for deflection. • Apply grease to caster ball bearings if needed. • Check welding joints for rust and crack. 	• • •	• • •	• •
4. Cleaning : <ul style="list-style-type: none"> • Any time needed. 			•
5. Actuator & Control Box: <ul style="list-style-type: none"> • Make sure the control box is firmly affixed to the mast. • Make sure the pins firmly affix the actuator to the Boom and the Mast. • Make sure the connecting cable of actuator and control box is not loose. • Make sure that the Battery Indicator shows at least 2 green LED prior to use. 	• • • •	• • • •	

6. Slings & Sling Hardware:			
<ul style="list-style-type: none"> • Check sling for wear. • Check sling hardware before use. 	•	•	
	•	•	

Trouble Shooting:

Symptom:	Corrections:
Cannot lift patient up and battery indicator shows no GREEN light.	<ul style="list-style-type: none"> • Charge the batteries.
Lift does not work and the battery indicator shows full charge.	<ul style="list-style-type: none"> • Check connection between the actuator and the control box. • Check connection between pendant & control box.
Lift does not work and the battery indicator shows no light.	<ul style="list-style-type: none"> • Make sure the emergency stop button is released. • Check connection of the batteries in control box.
Stop-and-Run while lifting or lowering patient.	<ul style="list-style-type: none"> • Check socket for pendant plug-in. • Check pendant cable.
Battery Indicator shows no light when charger is connected to power supply	<ul style="list-style-type: none"> • Check the emergency stop button is released. • Check charger plug for damage. • Check charger cable for damage.
Lift does not work. Battery indicator shows full charge. Notice “click” sound from control box when UP or DOWN button on hand control was pressed.	<ul style="list-style-type: none"> • Actuator problem.

WARNING: If you experience a problem with your lift and are unable to service it yourself, contact Proactive Medical or your Proactive authorized distributor.

ACCESSORIES:

Toileting Sling

The Toileting Sling can be used with the Protekt® 600 Stand lift to lift a patient in a sitting position. When in use, the Toileting Sling supports the client under the thighs and across the mid-back area.



Safety Note: The Toileting Sling is not suitable for patients who have involuntary movements, or patients with limited postural control.

Fitting The Toileting Sling

1. Slide the sling down patients back to lumbar position.
2. Draw shoulder straps under the arms and around the chest into the front.
3. Draw Velcro waist belt around waist and press together to fasten.
4. Draw each leg support under the thigh.
5. Crisscross leg straps by feeding one of the leg straps through the other strap.
6. Attach shoulder straps to hooks in upper ends of the lifting arms.
7. Attach leg straps to hooks in the lower ends of the lifting arms.

LIMITED WARRANTY

The Protekt® 600 Stand you purchased is guaranteed to be free from defects in material and workmanship under normal use and service. The warranty period for this product is 2 Years Electronics/3 Years Frame from the date of purchase by the original purchaser. This warranty shall be voided upon transfer of ownership of this product. Proactive Medical agrees to repair or replace this product, at our discretion and at no charge, within the warranty period provided and that Proactive Medical consents the unit is defective. The repaired or replacement unit shall be warranted for a period equal to the balance of the defective unit's warranty period.

NOTE:

To ensure the best service to our customers, Proactive Medical requires the following information to be included with the returned unit:

1. Model Name/Number and Serial Number on the packaging.
2. Proof of purchase, i.e. a copy of the original invoice.
3. A Return Authorization number (RA#) obtained by calling Authorized dealer/distributor prior to the return of the product. The RA# must be clearly indicated on the outside of the packaging.
4. A detailed description of the problem and its symptoms on a note.

This warranty shall not apply to any product which has been repaired or altered in any way so as, in our judgment, to affect its functionality and durability, nor to any product subject to abuse, misuse, negligence or accident, improper maintenance, improper installation, nor to any product used with other parts, components and/or accessories with quality and/or specifications not compatible with this product. This warranty does not cover products that have been impaired by occurrences considered Acts of God over which authorized dealer has no control. This warranty shall also be voided if any required periodic maintenance, if applicable, has not been properly performed on this product.

This warranty and the aforementioned remedies presented are exclusive and in lieu of all other express or implied warranties. No other representations or claims shall be binding or obligate authorized dealer in any way. Any warranty applicable to this product is limited to the aforementioned period indicated. In no event shall authorized dealer be liable for any special, incidental, or consequential damages; loss of revenue; or cost of replacement goods; resulting from the use or malfunction of this product to the associated equipment on which and with which it is used. This warranty gives specific legal rights and you may be entitled to other rights that vary from state to state.