

drive™

PRIMECARE®

Sit to Stand Lift

OWNER'S MANUAL



Items#

STSP450 (Power Base)

STSM450 (Manual Base)

DEALER: This manual must be given to the user of the patient lift.

USER: Before using this patient lift, read this manual and save for future reference.

SERVICE AGENT: Only Drive DeVilbiss Healthcare authorized service agents are permitted to install, service or repair DRIVE product.

99 SEAVIEW BLVD.
PORT WASHINGTON, NY 11050



TABLE OF CONTENTS

STANDARD SYMBOLS USED IN THIS MANUAL	3
INTENDED USE	4
CONTRA-INDICATIONS	4
GENERAL SAFETY	5
ELECTROMAGNETIC EMISSION AND IMMUNITY.....	8
FEATURES AND BENEFITS.....	11
TECHNICAL SPECIFICATIONS	12
COMPLIANCE INFORMATION.....	13
UNPACKING INSTRUCTIONS.....	13
ASSEMBLY	14
OPERATION.....	18
BATTERY INFORMATION.....	26
CARE AND MAINTENANCE.....	27
SERVICING	29
TROUBLESHOOTING GUIDE.....	31
WARRANTY	32
END OF LIFE DISPOSAL	33

NOTE: DO NOT operate this product without first reading and understanding this user manual. Damage or injury may result from improper use of this product.

The Drive DeVilbiss Healthcare's Sit to Stand Lifts

Product#	Product Name	Power/Manual Base	Weight Capacity
STSP450	Sit to Stand Lift	Power	450lbs
STSM450	Sit to Stand Lift	Manual	450lbs

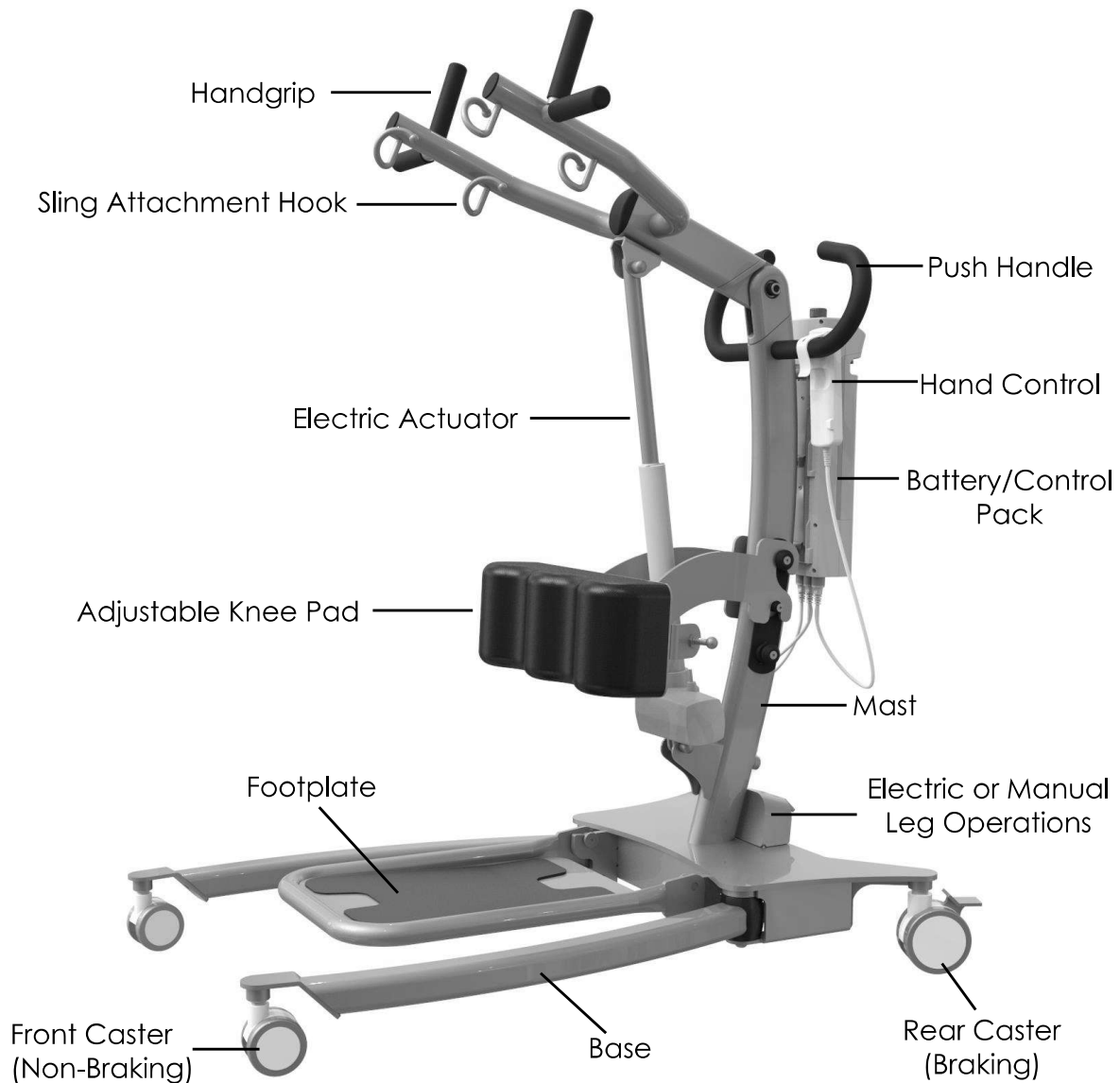

STANDARD SYMBOLS USED IN THIS MANUAL

This manual includes important information about the safety of personnel and equipment. As you read through this manual be aware of the symbols and their meanings.



DANGER

Information that appears under the DANGER symbol concerns the protection of personnel from direct and pending hazards that, if not avoided, will result in immediate, serious personal injury or death in addition to damage of the equipment.



DANGER SHOCK HAZARD

Information that appears under the DANGER SHOCK HAZARD symbol concerns the protection of personnel from possible hazards related to electrical shock.



FIRE HAZARD

Information that appears under the FIRE HAZARD symbol concerns the protection of personnel from possible hazards related to fire and flammability.



WARNING

Information that appears under the WARNING symbol concerns the protection of personnel from possible hazards that can result in injury or death in addition to damage of the equipment.









CAUTION

Information that appears under the CAUTION symbol concerns the protection of personnel from possible hazards that may result in minor injury or damage of the equipment.

NOTE:

Information that appears with the NOTE text gives added information, which helps in understanding the item being described.

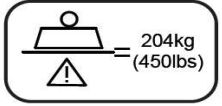
PRODUCT SYMBOLS

Symbols	Description	Symbols	Description
	Type B applied part equipment.		Intertek's ETL listed mark for US and Canada. A product bearing the ETL listed Mark is determined to have met the minimum requirements of prescribed product safety standards.
IP24	According to IEC 60529. This lift is identified as equipment that is protected against solid foreign objects of 12,5 mm and greater and splashing water.		The symbol required to be displayed on regulated products for sale on the European Market. It indicates that the product complies with applicable European Directives related to health, safety, environment and consumer protection.
	The owner's manual must be read before operating the bed.		The disposal of electronics should not be mixed with general household waste
	Maximum safe working load. 204kg (450lbs)		For indoor use.
	Combined mass + SWL 271kg (597lbs)		

INTENDED USE

The intended use of this lifting device is for the safe lifting and transfer of an individual from one resting surface to another (such as a bed to a wheelchair). Drive DeVilbiss Healthcare recommends that the transfer of a patient is fully risk assessed and conducted safely over a short distance only.

The lift is a battery powered, mobile electric sit to stand lift intended for individuals at home, hospital and institutional healthcare environment use, the lift is indoor use only.

The lift designed to support and promote safe patient handling and transfer for both the patient and caregiver.

The lift incorporates a 4-point hook as standard and is designed to be used in conjunction with, and only Drive DeVilbiss branded range of slings.

Note: The caregiver must only use two hooks at one time and they must be on the same level. The farther away two hooks are for a shorter person, closer hooks are for a taller person.

CONTRA-INDICATIONS

This lift should not be operated (control the movements of the lift through the control interfaces) by persons who do not have the cognitive skills to understand the information in the owner's manual or cannot understand and perform the proper operation of the lift.

This Lift should not be used by persons who are not able to support the majority of their own weight.

This lift should not be used or operated by children.

GENERAL SAFETY



WARNING

- Check all parts for shipping damage before using. In case of damage, DO NOT use the equipment. Contact the Drive DeVilbiss Healthcare for further instructions.
- DO NOT operate this lift without first reading and understanding the warnings, cautions and instructions in this manual. If you are unable to understand the warnings, cautions, and instructions, contact a healthcare professional, dealer or technical personnel if applicable before attempting to use this lift-otherwise injury or damage may result.
- Drive DeVilbiss Healthcare patient lifts may be safely operated by a single appropriately trained and experienced caregiver, in accordance with ISO 10535:2006. However, there are circumstances (including but not limited to the patient's medical, psychological or behavioral condition, as well as the caregiver's training, experience or physical limitations) that may require two people to safely operate the lift. It is the responsibility of each facility or caregiver to determine if more than one person is required to safely operate the lift at the time of transfer, depending on these circumstances. It is also the responsibility of each facility or caregiver to ensure that the lift is only operated without additional assistance, if circumstances safely allow, by someone who: (1) has thoroughly studied the instructions for use for both the lift and any accessories; (2) has adequate training and experience to determine that the lift may be safely operated without additional assistance; and (3) can operate the lift without assistance.
- DO NOT use the sling in combination with the lift as a transport device. It is intended to transfer an individual from one resting surface to another (such as a bed to a wheelchair).
- DO NOT attempt any transfer without approval of the patient's physician, nurse or medical assistant. Thoroughly read the instructions in this Instruction manual, observe a trained team of experts perform the lifting procedures and then perform the entire lift procedure several times with proper supervision and a capable individual acting as a patient.
- Individuals that use the sling MUST be able to support the majority of their own weight, otherwise injury can occur.
- DO NOT exceed maximum weight limitation of the Lift. The maximum weight limitation is 450 lbs. regardless of any additional weight limitations on accessories.
- DO NOT raise the patient to a full standing position while using the sling otherwise injury can occur.
- When lifting patient, make sure the base legs are in the most widely opened position and the rear caster are unlock. Otherwise, the lifter may tilt over.
- Before positioning the legs of the lift around the patient, make sure the patient's feet are out of the way of the footplate, otherwise injury can occur.



WARNING

- Drive DeVilbiss Healthcare's slings and patient lift accessories are specifically designed to be used in conjunction with DRIVE's patient lifts. Slings and accessories designed by other manufacturers are not to be utilized as a component of DRIVE's lift system. Use of these products is prohibited and will void DRIVE's patient lift warranty. Use only DRIVE's slings and patient lift accessories to maintain patient safety and product utility.
- ALWAYS check the sling is suitable for the particular patient and is of the correct size and capacity
- Before lifting the patient, make sure the bottom edge of the sling is positioned on the lower back of the patient and the patient's arms are outside the sling.
- The belt of Sling MUST be snug, but comfortable on the patient, otherwise the patient can slide out of the sling during transfer, possibly causing injury.
- ENSURE sling loops are pulled completely and rest securely on hooks
- NEVER use a sling, which is frayed or damaged
- When elevated a few inches off the surface being transferred from and before moving the patient, check again to make sure that the sling is properly connected to the attachment points of the lift. If any attachments are NOT properly in place, lower the patient back onto the surface and correct this problem.
- NEVER operate the lift with loose or missing parts or fasteners.
- Use push handle on the mast at ALL times to push or pull the lift
- DO NOT roll lift over deep carpet, raised carpet bindings or any uneven surfaces which may cause lift to lose its balance.
- DO NOT bump the lift down steps, loaded or unloaded.
- DO NOT push a loaded lift at speeds, which exceed a slow walking pace (2.6 ft/sec)
- DO NOT park a loaded lift on ANY sloping surface.
- DO NOT use or store in a wet or corrosive environment: shower, bath or pool locations.
- DO NOT attempt to negotiate a slope without a second helper being present.
- Push the "Emergency" red button if the control unit system is out of control.



WARNING

- DO NOT attempt to negotiate a loaded lift on a slope, which exceeds 1:12 (aprox. 5 degrees)
- The battery must be connected to an appropriate power source when loss of power source would result in an unacceptable risk
- DO NOT charge batteries in a bathroom or shower room.
- DO NOT place or store batteries under direct sunlight or near a heat source.
- Maintenance MUST be performed ONLY by qualified personnel.
- Regular maintenance of the Lift and accessories is necessary to assure proper operation.
- Do not modify this lift without authorization of the manufacturer. If unauthorized service is performed on any components the warranty is void



DANGER SHOCK HAZARD

- DO NOT roll the lift over any power or pendant cords.
- DO NOT open any actuators, control boxes, pendants or battery. Service and repair must only be performed by authorized service personnel. If unauthorized service is performed on any components the warranty is void.
- DO NOT allow the cord, electrical outlets, and electrical control box or hand pendant to become wet or submerged.
- DO NOT operate the lift if any electrical component such as the electrical outlet, connections, motor/actuator, battery or mechanical component has malfunctioned or has been damaged in any way.
- To avoid risk of electric shock, this equipment must only be connected to supply mains with protection earth when charging.



FIRE HAZARD

- DO NOT use near open flame or explosive gases.
- This lift should not be placed in an oxygen enriched environment.



CAUTION

- Drive DeVilbiss Healthcare recommends locking the rear swivel casters **ONLY** when positioning or removing the sling from around the patient
- Drive DeVilbiss Healthcare does **NOT** recommend locking the rear swivel casters of the lift when lifting and transferring an individual. Doing so could cause the lift to tip and endanger the patient and assistants. Drive DeVilbiss Healthcare does recommend that the rear swivel casters be left unlocked during lifting and transferring procedures to allow the lift to stabilize itself when the patient is initially lifted from and transferred to a chair, bed or any stationary object
- This lift frame complies with EMC requirements of IEC 60601-1-2. Radio transmitting equipment, cell phones or similar electronic devices, used in proximity of the lift, may affect the lifts performance.
- Pinch Points: Feet and hands could be pinched. Keep feet and hands away from the pinch points.

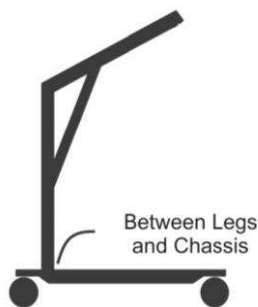

ELECTROMAGNETIC EMISSION AND IMMUNITY

This MEDICAL ELECTRICAL EQUIPMENT needs special precautions regarding EMC and needs to be installed and put into service according to the EMC information provided in the table below.

Portable and mobile RF communications equipment can affect MEDICAL ELECTRICAL EQUIPMENT



WARNING

The use of ACCESSORIES, transducers and cables other than those specified, with the exception of transducers and cables sold by the manufacturer of the EQUIPMENT or SYSTEM as replacement parts for internal components, may result in increased EMISSION or decreased IMMUNITY of the EQUIPMENT or SYSTEM.



WARNING

The ME EQUIPMENT or SYSTEM should not be used adjacent to or stacked with other equipment and that if adjacent or stacked use is necessary, the ME EQUIPMENT or SYSTEM should be observed to verify normal operation in the configuration in which it will be used.



DECLARATION - ELECTROMAGNETIC EMISSIONS

Guidance and manufacturer's declaration - Electromagnetic emissions		
The Prime Care™ STSP450, STSM450 is intended for use in the electromagnetic environment specified below. The customer or the user of the Prime Care™ STSP450, STSM450 should ensure that it is used in such an environment.		
Emissions Test	Compliance	Electromagnetic environment - Guidance
RF Emissions CISPR 11	Group 1	The Prime Care™ STSP450, STSM450 uses RF energy only for its internal function. Therefore, its RF emissions are very low and are not likely to cause any interference in nearby electronic equipment.
RF Emissions CISPR 11	Class B	
Harmonic Emissions IEC 61000-3-2	Class A	The Prime Care™ STSP450, STSM450 is suitable for use in all establishments including domestic establishments and those directly connected to the public power supply network that supplies buildings used for domestic purposes.
RF emissions CISPR 14-1	Complies	The Prime Care™ STSP450, STSM450 is not suitable for interconnection with other equipment.
RF emissions CISPR 15	Complies	

Recommended separation distances between portable and mobile RF communications equipment and the Prime Care™ STSP450, STSM450			
The Prime Care™ STSP450, STSM450 is intended for use in the electromagnetic environment in which radiated RF disturbances are controlled. The customer or the user of the Prime Care™ STSP450, STSM450 can help prevent electromagnetic interference by maintaining a minimum distance between portable and mobile RF communications equipment (transmitters) and the Prime Care™ STSP450, STSM450 as recommended below, according to the maximum output power of the communications equipment.			
Rated maximum output power of transmitter W	Separation distance according to frequency of transmitter m		
	150 kHz to 80 MHz $d = (1,2\sqrt{P})$	80 MHz to 800 MHz $d = (1,2\sqrt{P})$	800 MHz to 2,5 GHz $d = (2,3\sqrt{P})$
0.01	0.12	0.12	0.23
0.1	0.38	0.38	0.73
1	1.2	1.2	2.3
0.1	0.38	0.38	0.73
10	3.8	3.8	7.3
100	12	12	23
For transmitters rated at a maximum output power not listed above, the recommended separation distance d in meters (m) can be estimated using the equation applicable to the frequency of the transmitter, where P is the maximum output power rating of the transmitter in watts (W) accordable to the transmitter manufacturer.			
NOTE1: At 80 MHz and 800 MHz the separation distance for the higher frequency range applies			
NOTE2: These guidelines may not apply in all situations. Electromagnetic propagation is affected by absorption and reflection from structures, objects and people.			

Guidance and manufacturer's declaration: Electromagnetic Immunity

The Prime Care™ STSP450, STSM450 is intended for use in the electromagnetic environment specified below. The customer or the user of the Prime Care™ STSP450, STSM450 should ensure that it is used in such an environment.

Immunity test	IEC 60601 test level	Compliance level	Electromagnetic environment - guidance
Conducted RF IEC 61000-4-6	3 Vrms 150 kHz to 80 MHz	10 V	<p>Portable and mobile RF communications equipment should be used no closer to any part of the Prime Care™ STSP450, STSM450, including cables, than the recommended separation distance calculated from the equation applicable to the frequency of the transmitter.</p> <p>Recommended separation distance</p> $d = \left(\frac{3,5}{10} \sqrt{P}\right)$ $d = \left(\frac{3,5}{10} \sqrt{P}\right) \text{ 80MHz to 800MHz}$ $d = \left(\frac{7}{10} \sqrt{P}\right) \text{ 800MHz to 2,5GHz}$ <p>Where P is the maximum output power rating of the transmitter in watts (W) according to the Transmitter manufacturer and d is the recommended separation distance in meters (m). Field strengths from fixed RF transmitters, as determined by an electromagnetic site survey,^a should be less than the compliance level in each frequency range.^b</p> <p>Interference may occur in the vicinity of equipment marked with the following symbol:</p> 
Radiated RF IEC 61000-4-3	3 V/m 80 MHz to 2.5 GHz	10 V/m	

NOTE1: At 80MHz and 800MHz the higher frequency range applies.

NOTE2: These guidelines may not apply in all situations. Electromagnetic propagation is affected by absorption and reflection from structures, objects and people.

^a Field strengths from fixed transmitters, such as base stations for radio (cellular/cordless) telephones and land mobile radios, amateur radio, AM and FM radio broadcast and TV broadcast cannot be predicted theoretically with accuracy. To assess the electromagnetic environment due to fixed RF transmitters, an electromagnetic site survey should be considered. If the measured field strength in the location in which the Prime Care™ STSP450, STSM450 is used exceeds the applicable RF compliance level above, the Prime Care™ STSP450, STSM450 should be observed to verify normal operation. If abnormal performance is observed, additional measures may be necessary, such as reorienting or relocating the Prime Care™ STSP450, STSM450.

^b Over the frequency range 150 kHz to 80 MHz, field strengths should be less than 10 V/m.

FEATURES AND BENEFITS

- Provides stable assistance in standing, transferring and toileting.
- Four sling attachment hooks enable the lift to accommodate a variety of sling designs.
- Extra-wide, non-skid footplate provides a stable base for foot positioning.
- Soft, padded adjustable leg support.
- Easy-roll 4" rear casters and 3" front casters mean stability and easy maneuverability over a variety of surfaces.
- 24V DC motor provides power and reliability.
- Motor has an emergency stop button and manual lowering feature.
- Visual battery fuel indicator on hand control.
- Audible Alert if the lift is low battery power.
- Can be charged on, or off the lift.
- Includes removable, rechargeable battery (Figure A) , wall mount charger(Figure B) and external charging cradle (Figure C) (optional).
- Smart/Safety control module.
- LCD Display and maintenance feature (only on the STSP450)
- Redundant controls
- Overweight capacity



Figure A

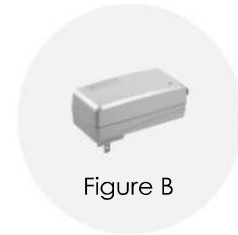

Figure B



Figure C

Lift Serial Numbers

When ordering parts or when contacting Drive DeVilbiss Healthcare Customer Service Department, please include lift's model and serial numbers, found on the identification labels as below. The identification labels are located on the legs of lift base

REF: STSP450 SN: (21)9WYYMM##### Max User Mass: 450 lbs / 204 kg Made in China 	VER.A.1.20  <small>8 22383 00138 8</small>	REF: STSM450 SN: (21)9WYYMM##### Max User Mass: 450 lbs / 204 kg Made in China 	VER.A.1.20  <small>8 22383 00139 5</small>
--	---	--	---

9W: Factory Code

YY : Manufacturing Year (two digits)

MM: Manufacturing Month (two digits)

#####: Six Sequential Digits

TECHNICAL SPECIFICATIONS

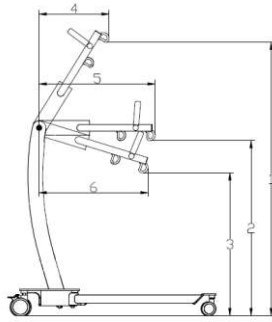

Hoisting Range/Reach

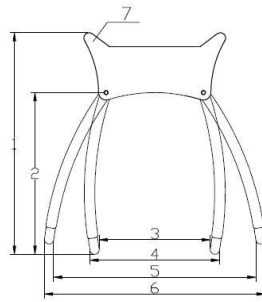

Base

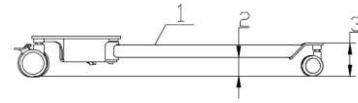

Base Height/Clearance

Hoisting Range/Reach (Unit: mm)

1. Max overall height.....1494
2. Height at Max reach.....956
3. Min overall height.....780
4. Hoisting reach at Max height...381
5. Max hoisting reach.....632
6. Hoisting reach at Min height....593
7. Base

Base (Unit: mm)

1. Max external length.....1069
2. Max internal length.....780
3. Internal width when closed.....534
4. External width when closed.....623
5. Internal width when open.....972
6. External width when open.....1061
7. Base

Base height/clearance (Unit: mm)

1. Base
2. Min clearance.....69
3. Max height.....120

ITEM	SPECIFICATION
Maximum Weight Capacity (SWL)**	450 lbs (204kg)
Product Weight	148 lbs (67kg)
Castors	3" (Front) 4"(Rear)
Brakes	Yes – Rear
Charger Input	100 - 240 VAC,50/60 Hz
Charger Output	28 VDC, 1.5 A
Maximum noise measured(sound level)	less than 65DB
Protective Earth Ground	Internally powered
Electrical Shock Protection	TYPE B
Enclosure Protection	IP24
Duty cycle	Min. 2min (on)/ Max. 18min (off)
Motor Anti-Entrapment	Yes
Emergence Stop	Yes
Emergence Lowering	Yes
Battery Model	BAT
Battery Type	Lead-Acid
Battery Capacity	2.9 or 5Ah
Battery Input voltage	29~45V DC
Battery Output voltage	24V DC, 2.9A or 5A

COMPLIANCE INFORMATION

Matching the correct lift components to meet regulatory specifications can be complicated. Drive DeVilbiss Healthcare offers a wide variety of compliance options and we can assist your facility in selecting components or accessories that are recommended for the specific lift model.

GENERAL INFORMATION

The recommended environment for operation and storage/transportation of the lift is listed below:

	Operation	Storage/Transportation
Ambient temperature:	10°C ~ 36°C (50°F~96.8°F)	-10°C ~ 50°C (14°F~122°F)
Relative humidity range:	30% ~ 75%	20% ~ 95%
Atmospheric pressure:	86KPa~ 106Kpa	70KPa~ 106KPa

This lift is classified for intermittent operation. Lift may be operated for 2 minutes out of every 20 minutes.

APPLIED PARTS LIST

- Lift Frame
- Pendant
- Handgrip
- Knee pad

MATERIALS ACCESSIBLE TO USER

- Surface Coating: Powder Coating
- Color of Powder: Grey
- Pendant Housing: ABS
- Surface of Handgrip: PVC
- Surface of Knee pad : PU

UNPACKING INSTRUCTIONS



CAUTION

Unpack the lift in an area with sufficient room to work. Do not allow patients near the lift until it has been completely set up and the work area has been cleared of all debris.

1. Inspect the lift for shipping damage. If the lift is damaged, do not use lift and immediately contact Drive DeVilbiss Healthcare for further instruction.
2. Verify the proper lift model was shipped. If you feel there was a mistake, do not use lift and immediately contact Drive DeVilbiss Healthcare for further instruction.
3. After verifying you've received the correct device without damage, cut strapping around box and remove enclosing lift.

NOTE: If the carton is in an upright position, slowly lower to the floor. It may be necessary for two or more people to help in lowering the lift.

4. Inspection of All Components - Receipt of assembled lift, the carton contains:
 - Sit to Stand Lift: Mast, Boom, Base, Footplate , Knee pad ,Battery /Control Pack;
 - Wallet containing documents;
 - Handset;
 - Charger;
 - Shifter Handle (for those lifts that have a manual base).

ASSEMBLY

KNOWLEDGE/SKILLS REQUIRED

- Ability to read and understand owner's manual
- Basic mechanical aptitude
- Ability to manipulate required tools

TOOLS REQUIRED

- Philips Screwdriver
- Adjustable Wrench
- Allen Wrench #13,14,16,18,20



WARNING

- Installation MUST be performed ONLY by qualified personnel.
- Avoid trapping fingers. Keep fingers away from the end of the mast when inserting into the base socket. Full engagement of the mast is indicated by the label on the side of the mast. The electric leg operation will not function unless the mast is fully engaged.

1. Remove all the parts from the carton and place on the floor, taking care to protect the finish from damage.

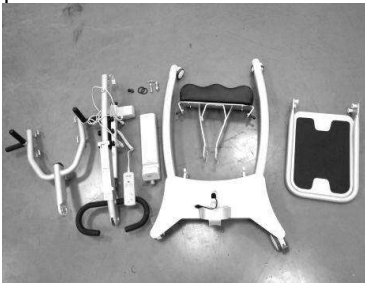

2. Place the base in a clear space and apply the rear brakes. If you are assembling a unit with a power base, connect the two power base connectors before sliding mast into base. Be careful to not damage the wire connectors.



3. Fit the mast into the base socket.

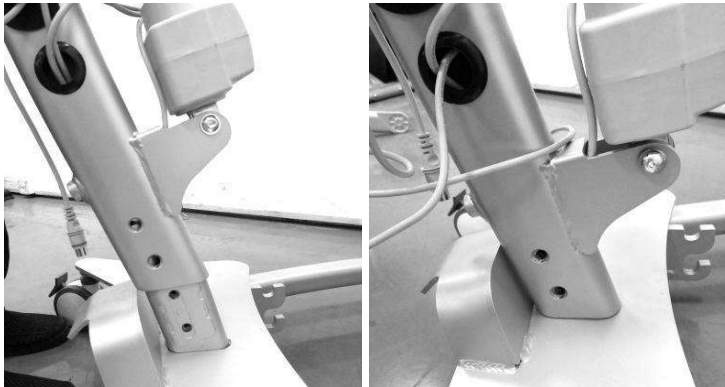

4. Secure the mast to the base with four hex screws (5/16"-18*5/8") and one hex set screw (1/4"-20*1/2").



5. If you are assembling the manual base, connect the manual leg adjustment shifter handle to the base with one hex set screw (1/4"-20*1/2").

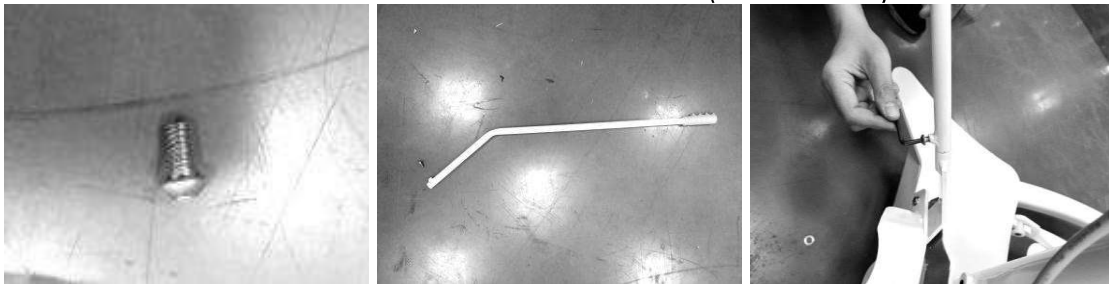

6. Put one nylon gasket on each side of the boom end, and fit the boom into the mast.

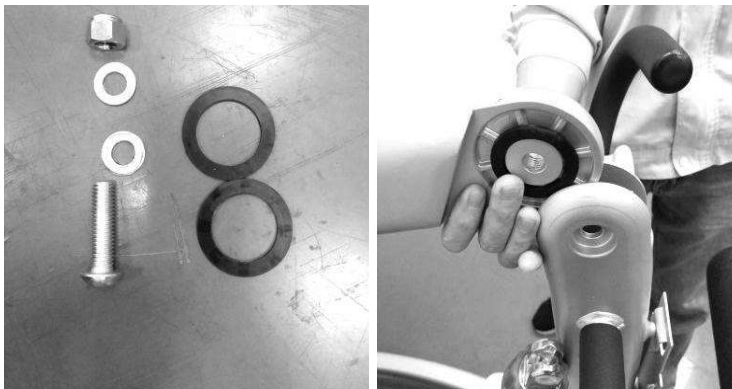

7. Secure the boom to the mast with one hex bolt (1/2"-13*1 3/4").

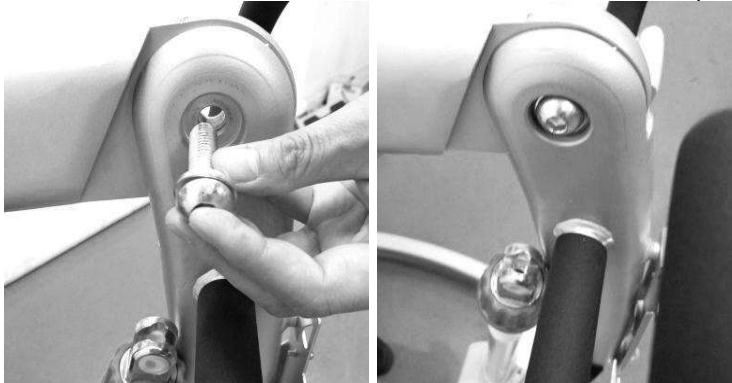

8. Secure the lifting actuator to the boom with the hex bolt (3/8"-16*2 1/4").



9. Install the control box onto the mounting bracket on the mast, and tighten the control box with two mounting screws (M4).



10. Fit battery to control box and make sure the latch holding the battery in place is fully engaged "Click" in place.

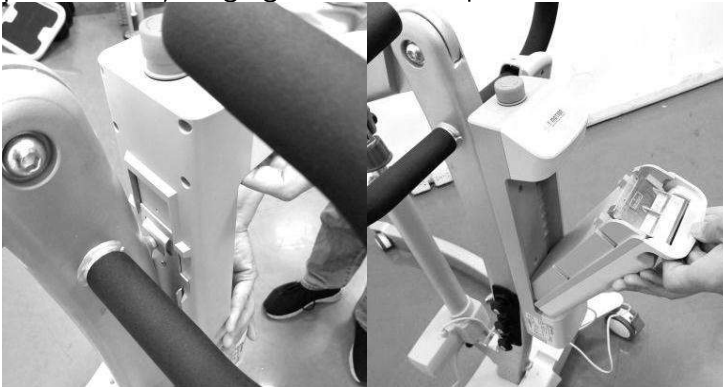

11. Plug the handset and actuator cables into the socket located on the bottom side of control box. Refer to the figures below for correct positions.

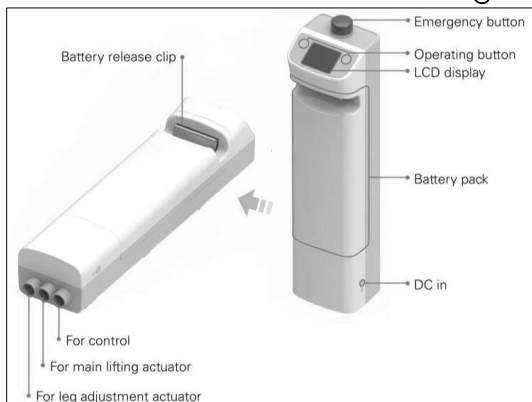

Figure D (for Power Base unit only)

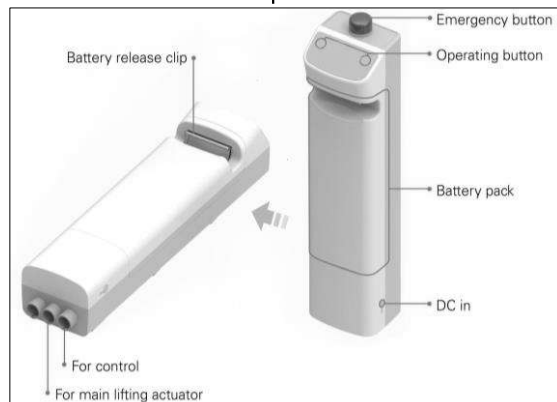

Figure E (for Manual base unit only)

12. Attach the footplate to the base



13. Attach the kneepad to the kneepad receiver



Note: The lift should not be disassembled unless for service, repair or transport if necessary. If disassembly is required, simply follow the assembly instructions in reverse sequence.

Note: Please always check the mast is fully locked into position.

OPERATION



WARNING

Always check the following before operation:

- The mast is fully locked into position.
- Confirm the boom rises and lowers (This is done via the hand control).
- The legs of the lift open and close satisfactorily (This is done via the hand control or shifter handle).
- Prior to first use, please make sure that the battery has been charged for 24 hours in order to reach proper function and prolong the lifetime of battery.

Locking/Unlocking the Rear Swivel Casters

- Locking - Press DOWN on the bottom of the locking lever.
- Unlocking - Press DOWN on the top of the locking lever.

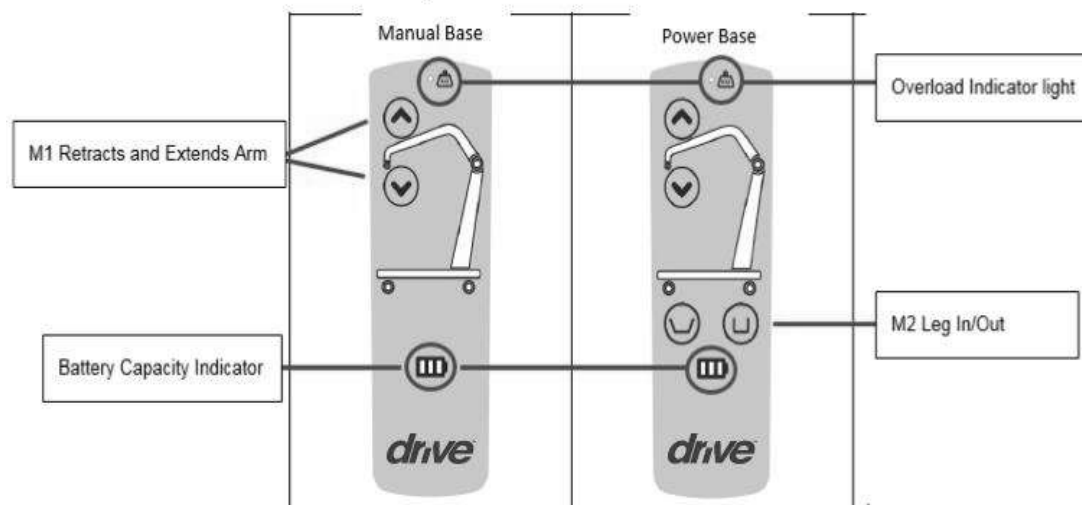
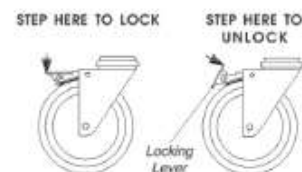

Definitions: M1 -Actuators for Lifting; M2 -Actuators for Leg Adjustments

Raising and Lowering the Lift

- Raising the lift -Press the (M1) UP button on the hand control to raise the lift arms and the patient.
- Lowering the lift -Press the (M1) DOWN button on the hand control to lower the lift arms and the patient.

NOTE: If the Lift is in the full UP position, it may be necessary to pull down slightly on the lift arms before the mast will lower.

Closing/Opening the Leg Base

Electric leg adjustment (STSP450)

- Opening the leg base- Pressing the (M2) left button widens the leg base;
- Closing the leg base-Pressing the (M2) right button closes the leg base.

Manual leg adjustment (STSM450)

- Opening/Closing the leg base-lowering on the shifter handle

Emergency Stop

The red Emergency Stop Button is located on the top of the control box and is activated by pressing in. This will cut all power to the lift and only be reset by twisting the button counter clockwise and releasing.

Mechanical Emergency Down

In the case of a complete electrical failure, the electrical actuator is fitted with a mechanical lowering red device on top of actuator.

It is twisted by hand to activate lowering. A slow decent will commence. Repeat this process until the patient has been safely lowered.



WARNING

If mechanical emergency lowering is used, the lift **MUST** be subsequently checked out by a qualified engineer.

How to Lift the Patient

1. Instruct the patient to do the following:
 - Hold onto the vertical or horizontal handgrips which even is more comfortable on both sides of the lift.
 - Lean back into the sling.
2. Make sure of the following:
 - Patient's knees are secure against the knee pad.
 - Patient's feet are positioned on the footplate.
 - The bottom edge of the sling is positioned on the lower back. Sling is at the base of the patient's spine.
 - The patient's arms are outside of the sling.
 - The rear casters are unlocked.
 - Make sure the legs are in the maximum open position.
3. If transferring from a wheelchair - Lock the wheel locks of the wheelchair.
4. Press the (M1) UP button to raise the patient above the surface (bed, wheelchair or commode) being transferred from. The patient should be elevated just high enough to clear the surface with their weight fully supported by the lift.

How to move the Patient

1. Using the push handle, move the lift away from the surface.
2. SLOWLY, move the patient to the desired surface.

How to transfer the Patient to the desired surface

1. Have the wheelchair, bed or commode in ready:
 - If transfer the patient to a wheelchair, move the wheelchair into position, lock the wheels of the wheelchair, position the patient over the wheelchair
 - If transfer the patient to a bed, position the patient as far over the bed as possible
 - If transfer the patient to a commode, position the patient over the commode.
2. Press the (M1) DOWN button and lower the patient onto the desired surface.
3. Lock the rear swivel casters of lift.
4. Unhook the sling from all attachment points on the lift.
5. Instruct the patient to lift their feet off of the footplate.
6. Remove the sling from around the patient.
7. Pull the lift away from the wheelchair, bed or commode.

SMART/SAFETY CONTROL MODULE

Redundant Control

The Drive DeVilbiss Smart/Safety control module has two operation buttons and an LCD display (STSP450 only) on the top of control box (TC12), redundant controls for operation if the hand control becomes inoperable, battery and an emergency stop button.

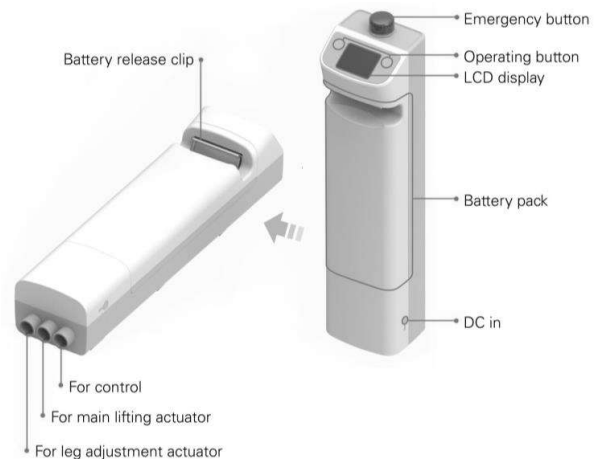



Main features:

- Raise/Lower Hoist, Legs open/close (with power base only)
- Visual battery capacity read out will alarm when battery is at lower capacity
- Control box is equipped with overload protection for the lifting and leg spreading function.
- Emergency stop button disconnects power supply. Battery cannot be charged if emergency button is in lower.
- Charger is integrated in the control box or can be charged externally using the charging stand included.

Control Box (TC 12) User Guide (STSP450 Only)

1. If you press either button(see Figure F) for less than 0.5 seconds, you can access the following screens:

<p>Raise or lower the hoist.</p> 	<p>Adjust the distance between the hoist legs.</p> 	<p>Remaining battery capacity.</p> 
--	--	--

2. Press the buttons to begin actuator extension and retraction.

<p>Left button: Pressing the left button for more than 0.5 seconds will begin actuator extension.</p>	 <p>Figure F</p>	<p>Right button: Pressing the right button for more than 0.5 seconds will begin actuator retraction.</p>
---	--	--

The Smart/Safety Control Module

(STSP450 Only) The Drive DeVilbiss Smart/Safety control module stores useful servicing information about the lift that can be recalled when required. This servicing information includes:

- Number of patient lift cycles
- Total work done by actuator
- Number of lift overloads (attempted lifts above the safe working load)
- Number of days since last service interval

The Drive DeVilbiss Smart/Safety control module contains a microprocessor inside making it possible to read out service data via the on-board LCD screen. This information and setting can only be performed by using the Smart/Safety learning hand control (see Figure G)

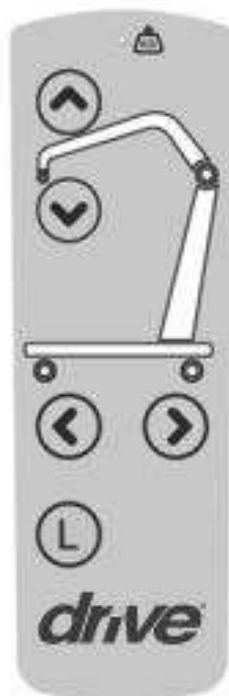

Figure G

Features

- Data collection in the control box with data display via LCD screen
- Work counter
- Intelligent cycle counter
- Service indicator
- Service interval indicator
- Overload information
- 3 step battery indicators

Benefits

- Improved safety for both patient and care giver
- Accurate service data available at the touch of a button
- Optimized product life time
- Ease of maintenance for engineers and service technicians

1. Getting Started (STSP450 Only)

- Connect the Smart/Safety learning hand control (see Figure G) for the setting mode.

- Press  to start the learning mode.

2. Language Setting

- We have six (6) standard options: English, Chinese, German, French, Japanese, and Spanish.

- Press the  or  to select the language menu.





- Press the  or  buttons to select the desired language or return to the main menu.



- After selecting the desired language, press and hold the button  for 5 seconds to complete the process.

3. Maintenance Cycle Setting (STSP450 Only)



- Press the  or  buttons to select the maintenance cycle menu.

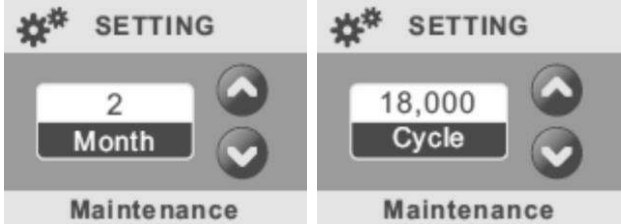

- Press the  or  buttons to navigate to the maintenance cycle menu or return to the main menu.

- Make your maintenance interval selection based on a time period or fixed number of cycles.





- Press the  or  buttons to adjust the time period or cycles.
- The time interval is adjustable in monthly increments and cycles are adjustable in increments of 1000.

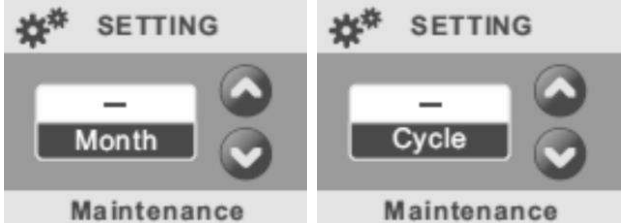

- If you don't want to set up the maintenance cycle, press the  button until the following symbol appears:



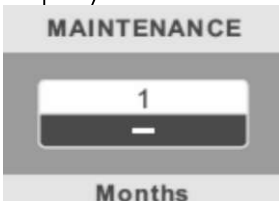
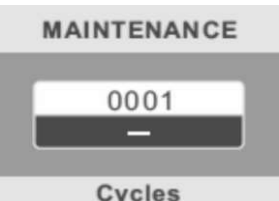

Maintenance Information

		If you do not input a maintenance period, the message below will be shown on the display:	
			

4. System Reset (STSP450 Only)

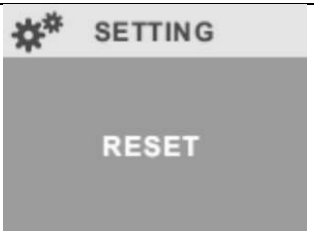
- Press the  or  to navigate to the reset menu.



- Press the  or  buttons to select after maintenance or return to the main menu.

- "After Maintenance" System Reset
Note: The maintenance interval settings are regulated by the number of cycles or months. An example is shown below.

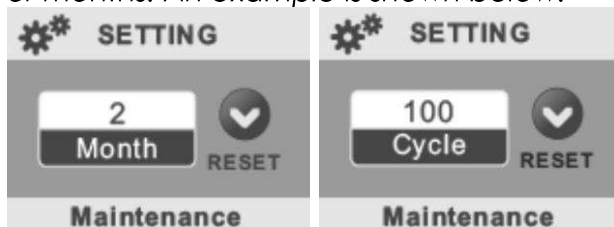

- Resetting the maintenance interval to 0
Before the reset –the display will appear similar to the images shown below.

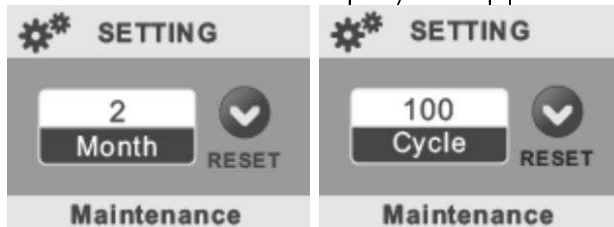



- To reset the maintenance interval, press and hold the button  for 5 seconds. When this process is completed, the values will be reset to zero.

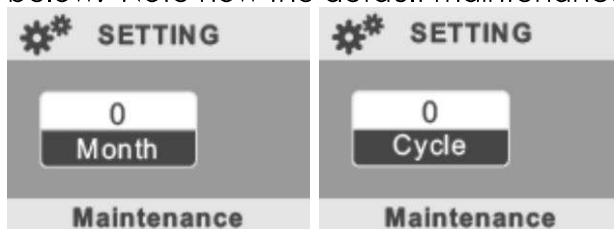

- After the reset is complete, the screen will appear similar to the images shown below. Note how the default maintenance time or cycle will start from zero (0).



5. Usage History (STSP450 Only)

- Press the  or  buttons to navigate to the Usage History menu.



- Press the  or  buttons to scroll through the Usage History information or return to the main menu.

Note: The Usage History menu includes information regarding the total usage and the last five usages.

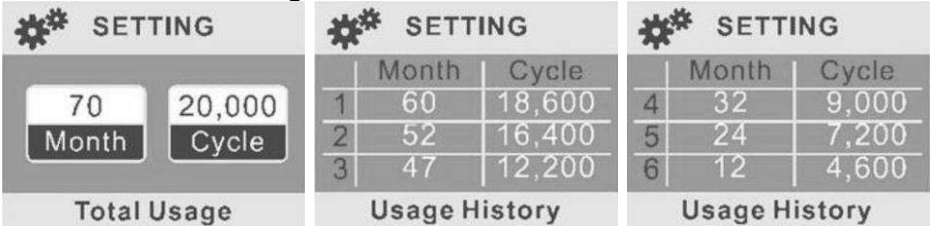





	Month	Cycle
1	60	18,600
2	52	16,400
3	47	12,200

	Month	Cycle
4	32	9,000
5	24	7,200
6	12	4,600

Notifications

If the following notifications appear on the LCD display, please follow the procedures listed below to troubleshoot:

<p>Maintenance notification: Check the state of the hoist and actuators</p>	<p style="text-align: center;">ATTENTION</p> <div style="text-align: center;">  Maintenance Required </div>
<p>Low battery capacity: Recharge battery. If it does not hold a proper charge, the battery will need to be replaced.</p>	<p style="text-align: center;">ATTENTION</p> <div style="text-align: center;">  Recharge Or Exchange </div>
<p>Overload alarm: Weight has exceeded the set maximum limit. Remove weight from the hoist and retry.</p>	<p style="text-align: center;">ATTENTION</p> <div style="text-align: center;">  Overloaded </div>
<p>Force interference: When the primary motor retracts (hoist lowers), if any force interference occurs, an electrical push only mode will be activated and the hoist will stop working. Remove the interference immediately.</p>	<p style="text-align: center;">ATTENTION</p> <div style="text-align: center;">  Please Check Hoist </div>

BATTERY INFORMATION



WARNING

- The only compatible battery is the Timotion BAT battery.
- Must follow the rated input voltage.
- Charge with certified charger from original manufacturer.
- Don't expose the battery to water or heat source.
- Recycle with certified depots. Batteries must be disposed of in accordance with local regulations.
- Repair by authorized maintenance centers.
- Never touch battery/charger terminals with any metal object.
- Keep the batteries fully charged. Place the battery on the charger whenever it is not in use. If it is convenient, place the battery on charger every night. The charger will not overcharge the battery.
- DO NOT leave the battery pack connected with the charger unplugged.
- DO NOT leave the charger plugged in with no battery connected.
- DO NOT charge batteries in wet environment or a bathroom or shower room.
- When the lift is low battery, the LED indicator on hand control will change from green to orange, the control box will give "beep" warning. At this moment, you should charge the battery immediately. Please note that a lifted patient cannot be lowered down when battery is out of power.
- If the lift is stored for a long period of time, the battery capacity can be harmed. Be sure to charge the battery every 24 hours or every 6 months at a minimum.
- The product should be charged continuously at least 24 hours under following circumstances:
 - First operation
 - Before long period storage without AC-in
 - First operation after long period storage

BATTERY CAPACITY

Status on Battery

LED indicator on handset will show you the status on battery

LED	Status	Voltage
Green	Low Battery Warning	24.0-24.5V
Green	Low Battery	24.0-24.5V
Green	Medium Battery	25-25.6V
Orange	High Battery	>25.6V

The batteries are protected from deep discharge by a lower voltage alarm. This will sound when the batteries need recharging and the hand control is being operated. It will not sound independently of the hand control being operated.

Note: DO NOT ignore this warning alarm. Complete the lifting operation and charge the battery pack immediately.

BATTERY CHARGING INSTRUCTIONS

When the power pack needs to be charged,

1. There are two possibilities to charge the battery:
 - Battery can be charged directly through control box, connect charger to control box DC jack then you can charge the battery. **Please release emergency button before charging. Charge will not be possible if emergency button is locked.**
 - Battery can also be charged on charging cradle, remove battery pack from the lift. The pack is retained by a simple latch at the top of the battery pack. Lift the latch and the battery pack will be released.
Fit the battery pack to the charging cradle, connect charger to the charging cradle DC jack, then you can charge that battery.
2. Charging is automatic and will fully charge the batteries over a period of approximately 14 hours.
3. To return the lift to service,
 - a. When battery is being charged on control box, simply unplug the charger.
 - b. Unplug the charger and remove the battery pack from the charging cradle.
Fit the battery pack to the lift and make sure the latch holding the battery pack in place is fully engaged. "Click" in place.

CARE AND MAINTENANCE

CONTACT DETAIL

Maintenance and Service MUST be performed ONLY by qualified personnel
Contact Drive DeVilbiss Healthcare if you need any help with installation, usage or maintenance of the product.

Corporate Office: Drive DeVilbiss Healthcare, 99 Seaview Blvd.,
Port Washington, NY 11050. Ph: 1-877-224-0946 Fax: 516-988-4601

Website: www.drivemedical.com

Manufacturer: Xiamen World Gear Sports Goods Co., Ltd.

CLEANING INSTRUCTIONS

- Prior to cleaning unplug power supply cords
- Ensure all electrical parts (motors, control boxes, wires and pendant) are not broken. Ensure that NO liquids enter electrical components.
- Remove all gross/solid contaminants, then wash and sanitize all components. DO NOT submerge the lift frame or electrical components.
- Clean surfaces using a cloth moistened with a solution of one part lanolin hand cleaner to nine parts water.
- After cleaning, wipe down all surfaces using a dry towel to remove any residue.
- A 70% Isopropyl Alcohol solution can be used as well.
- Do not use cleaners such as Lysol®, Armor All®, Windex®, or other abrasive detergents to clean upholstered surfaces or hand grips. These products will remove moisture from the Naugahyde® upholstery and PU hand grips, resulting in premature cracking.
- Solvents, alcohol, bleach, caustic agents, high acid or alkaline solutions or petroleum based products should not be used on the lift.
- Use standard water pressure. DO NOT power wash or steam clean any parts.
- Rinse completely with water (Maximum temperature 110°F or 43°C). Do not rinse with cold water.
- Ensure all parts are dry before using or storing.
- Never use harsh chemical cleaners or abrasives.

NOTE: *This Lift is NOT compatible with wash down tunnels.*

MAINTENANCE SCHEDULE



WARNING

- All Drive DeVilbiss products are designed for minimum maintenance, however some safety checks and procedures are required. A schedule of DAILY tasks is detailed below. Daily checks and a yearly service, inspection and test will ensure a lift is kept in optimum safe working condition. A list of spare parts is available upon request.
- Drive DeVilbiss Healthcare recommends regular inspection and maintenance. Please refer to the chart below.
- Maintenance **MUST** be performed **ONLY** by qualified personnel.

Item	Pre-Delivery	Daily	Minor Service (After every 3 Months of Service)	Major Service (After every 6 Months of Service)
PRE-DELIVERY				
<ul style="list-style-type: none"> • Confirm all components are included. • Inspect parts for possible damage in transit. 	√ √			
COMPLETE LIFT				
<ul style="list-style-type: none"> • General inspection of Lift. Visually inspect the patient lift for external damage or wear. Scratches and chips. 	√	√	√	√
BASE AND CASTORS				
<ul style="list-style-type: none"> • Inspect for missing hardware. • Base opens/closes with ease. • Inspect castors and axle bolts for tightness. Make sure tightly attached to legs. • Inspect castors for smooth swivel and roll. • Check castor brakes operate efficiently. • Overhaul castors and repack with grease. • Check tightness of bolt in leg bushes. • Check linkages are secure in leg adjuster ball joints. 	√ √ √ √ √ √ √		√ √ √ √ √ √ √	√ √ √ √ √ √ √
MAST				
<ul style="list-style-type: none"> • Mast MUST be securely assembled to boom. • Inspect for bends or deflections. • Check Sling hooks for wear or deflection. 	√ √ √	√	√ √ √	√ √ √
ELECTRIC ACTUATOR ASSEMBLY				
<ul style="list-style-type: none"> • Check hand control and cycle to ensure smooth quiet operation. Lift adjustment on all Lifters. Width also for those with electric leg adjustment. • Emergency lowering function (electric and mechanical) • Check for wear or deterioration. • Inspect hardware on mast and boom. • Remove dust and dirt from actuator with cloth. 	√ √ √ √	√ √	√ √ √ √	√ √ √ √
BOOM				
<ul style="list-style-type: none"> • Check all hardware and swivel bar supports. • Inspect for bends or deflections • Inspect bolted joints of boom for wear • Inspect to ensure that the boom is centered between the base legs. 	√ √ √ √		√ √ √ √	√ √ √ √

Item	Pre-Delivery	Daily	Minor Service (After every 3 Months of Service)	Major Service (After every 6 Months of Service)
SLINGS AND HARDWARE				
<ul style="list-style-type: none"> • CHECK ALL SLING ATTACHMENTS each time it is used to ensure proper connection and patient safety. • Inspect sling material for wear. • Inspect straps for wear. 	√	√	√	√
CLEANING				
<ul style="list-style-type: none"> • Whenever necessary. Clean the lift per CLEANING INSTRUCTIONS in the CARE AND MAINTENANCE section of this manual 		√	√	√
SHIFTER HANDLE (Manual Leg Adjustment Only)				
<ul style="list-style-type: none"> • Operates smoothly. • Locks adjustable base whenever engaged. 	√		√	√
ON COMPLETION OF CHECK or SERVICE				
<ul style="list-style-type: none"> • Arrange repair/replacement of any faulty parts. 	√	√	√	√

SERVICING



WARNING

The power system includes battery, charger, handset, actuators and control box, they are not to be opened by unauthorized personnel, contact your distributor for warranty.

ACTUATORS WIRING

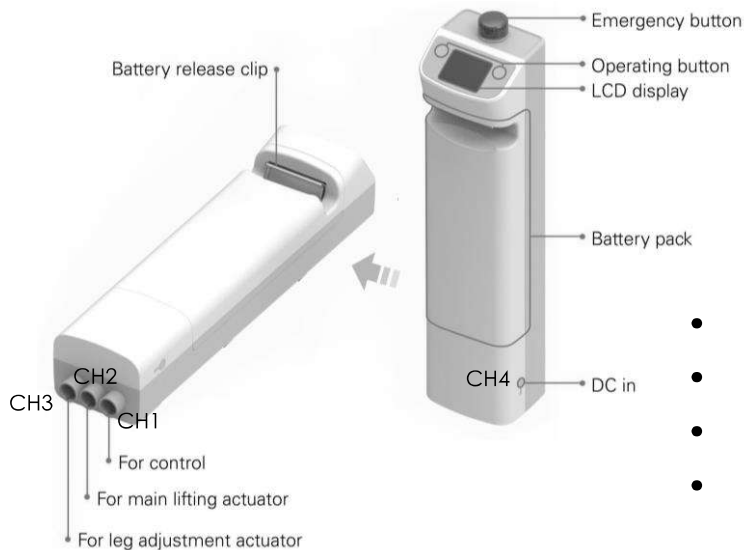

- CH1: Control box.
- CH2: Actuator for lifting.
- CH3: Actuator for leg adjustment.
- CH4: Wall mount charger /Charging cradle

ROUTING LAYOUT



WARNING

When routing cables in the medical lift, precautions shall be taken to avoid squeezing between parts of the lift.

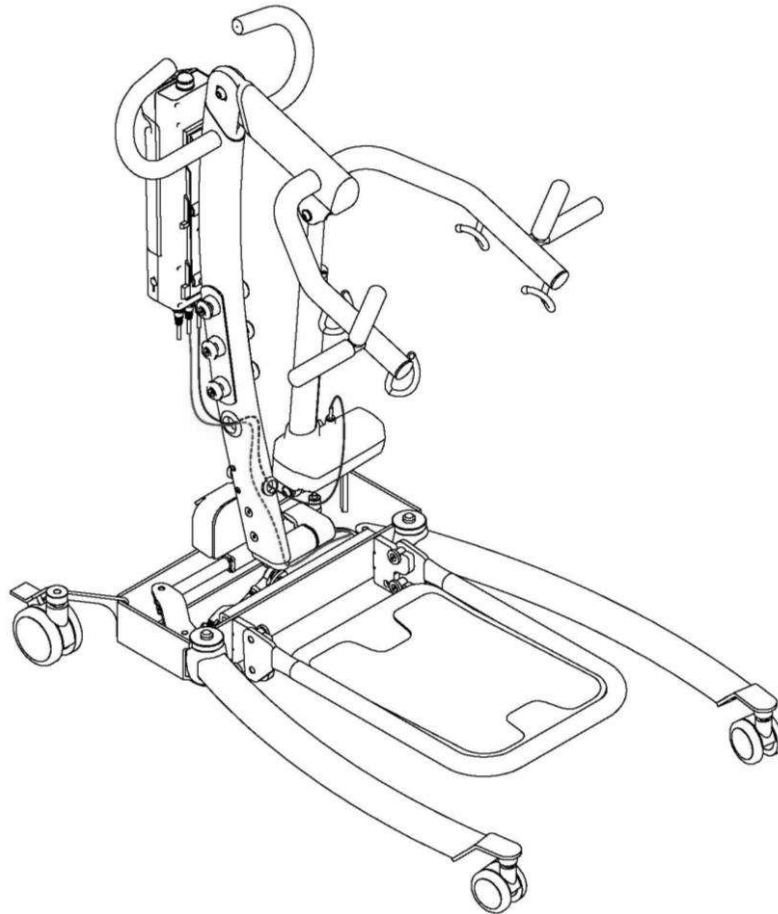

REPLACING CONTROL /BATTERY PACK

1. Install the bracket on the Lift Mast



2. Install the control box on the bracket



3. Make sure all fasteners are tightened properly

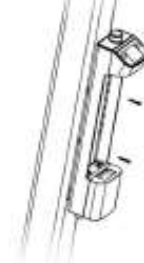

4. Install the battery



5. Installation is completed



TROUBLESHOOTING GUIDE



WARNING

Before doing any repairs or maintenance to the lift frame, read all instructions, cautions, and warnings. Repairs should be done by a skilled technician.

Normal Symptom	Possible Cause	Solutions
Patient Lift feels loose.	<ul style="list-style-type: none"> • Mast/Base joint loose. • Tie - Rods are loose. 	<ul style="list-style-type: none"> • Refer to ASSEMBLY section in this manual. • Check the Base Adjustment <ol style="list-style-type: none"> 1. Check the squareness of the legs when in the closed position. 2. Place a square on the inside of the legs and base to determine the 90° alignment. 3. Adjust the linkage rods until 90° alignment achieved
Boom will not lower in upper most position.	<ul style="list-style-type: none"> • Boom requires a minimum weight load to lower from the upper most position. 	<ul style="list-style-type: none"> • Pull down slightly on the lift arm.
Power indicator is not on	<ul style="list-style-type: none"> • Malfunction handset • Battery is out • Battery is damaged • Control box is damaged 	<ul style="list-style-type: none"> • Replace handset • Charge battery • Replace battery • Replace control box
Power indicator is on, actuator does not run and control box has clicking sound	<ul style="list-style-type: none"> • Actuator connector is damaged • Actuator is not connected • Actuator is damaged • Control box is damaged 	<ul style="list-style-type: none"> • Replace actuator • Connect actuator to control box • Replace actuator • Replace control box
Power indicator is on, actuator does not run and control box has no clicking sound	<ul style="list-style-type: none"> • Control box is malfunction • Handset is malfunction • Handset is not connected • Emergency button is pressed • Control box is charging 	<ul style="list-style-type: none"> • Replace control box • Replace handset • Connect handset • Reset/release emergency button • Unplug charger
Control box is not responsive with no indicator and no movement from actuator	<ul style="list-style-type: none"> • Battery is completely discharged • Battery is damaged 	<ul style="list-style-type: none"> • Charge the battery • Replace battery
Actuator could only operate in one direction	<ul style="list-style-type: none"> • Handset is malfunction • Control box is malfunction 	<ul style="list-style-type: none"> • Replace handset • Replace control box
After pressing handset buttons, there is a buzzer sound from control box and actuator is not moving	<ul style="list-style-type: none"> • The object on device is overweight • Actuator is damaged 	<ul style="list-style-type: none"> • Remove/reduce weight on device • Replace actuator



WARRANTY

PrimeCare STSP450, STSM450 Sit to stand Lifts are guaranteed for a 5 year period from the date of production. This guarantee is against defects in materials and craftsmanship, under normal use and service.

This 5-year warranty includes electrical and mechanical parts and components. Lift mounted accessories are covered for 1 year. Welds are covered under a limited lifetime¹ warranty of the product. Steel structural components are covered under the 15-year warranty from the date of production. During the warranty period, defective items will be repaired or replaced at Drive DeVilbiss Healthcare's option at no charge.

- ✓ Limited Lifetime warranty on welds. (¹ Weld lifetime defined as 20 years from date of production)
 - ✓ 15 year warranty on structural steel frame.
 - ✓ 5 year warranty on electrical and mechanical parts and components.
 - ✓ 1 year warranty on battery and all other parts and components.
-
- The PrimeCareSTSP450, STSM450 lift should only be used for its intended purpose and must be maintained and serviced in accordance with the instructions contained in this Owner's Manual.
 - This warranty will not apply if damage or mechanical failure is caused by abuse, improper assembly/use/cleaning/repair, accident, negligence, unauthorized alteration, or use in inappropriate environmental conditions, or failure to maintain the product consistent with user and service instructions.
 - Any change, adjustments, or repair not performed by a Drive DeVilbiss Healthcare Authorized Distributor or technician, will void the warranty.
 - This warranty is extended only to the original owner who purchased this product new and unused from Drive DeVilbiss Healthcare or a Drive DeVilbiss Healthcare Authorized dealer/Distributor. Warranty is not extended and is not transferable or assignable to any subsequent purchaser or future owners.
 - Drive DeVilbiss Healthcare's liability shall not exceed the original purchase price of this product.
 - Any Repair work or replacement components provided shall not extend the warranty beyond the original warranty period.
 - Request for Warranty coverage must be accompanied by valid serial number from the lift. Coverage is void if serial number has been removed, defaced, or altered.

PARTS

Some products are not covered under the 5-year warranty but do fall under the 90 day warranty. Drive DeVilbiss Healthcare's responsibility under this warranty is limited to supplying replacement parts, servicing or replacing, at its option, which are found to be faulty by Drive DeVilbiss Healthcare.

Warranty replacement parts are covered by the warranty until the product's 5- year warranty period expires. For warranty replacement, Drive DeVilbiss Healthcare requests that broken parts be sent back to them for evaluation. A credit will be issued only after the inspection and determination of cause.

SERVICE

A majority of service requests can be handled by the facility maintenance department with assistance from Drive DeVilbiss Healthcare tech support. Contact Drive DeVilbiss Healthcare tech service department if you need further help.

Most parts can be shipped next day air at the customer's expense.

This warranty is extended to the original purchaser of the equipment.

SALES AND SERVICE

Contact Drive DeVilbiss Healthcare if you need any help with installation, usage or maintenance of the product.

Corporate Office: Drive DeVilbiss Healthcare, 99 Seaview Blvd., Port Washington, NY 11050

Ph: 1-877-224-0946 Fax: 516-988-4601

Website: www.drivemedical.com

Manufacturer: Xiamen World Gear Sports Goods Co., Ltd.

END OF LIFE DISPOSAL

- Many components of this product may be recycled.
- Please dispose of non-recyclable items properly.



This marking indicates that this product should not be disposed with other household wastes throughout the EU. To prevent possible harm to the environment or human health from uncontrolled waste disposal, recycle it responsibly to promote the sustainable reuse of material resources. To return your used device, please use the return and collection systems or contact the retailer where the product was purchased. They can take this product for environmental safe recycling.

NOTE: *The information within this document is subject to change without notice. This manual includes important information about safety of personnel and equipment. As you read through this manual be aware of the four signal indicators.*



Owner's Manual
REV2.7.14.20



Drive DeVilbiss Healthcare, 99 Seaview Blvd., Port Washington, NY 11050

Ph: 1-877-224-0946 Fax: 516-988-4601

www.drivemedical.com

REV2.7.14.20

